

NAVWEPS 16-30ARC5-501

Handbook
BENCH TEST
And
ALIGNMENT PROCEDURE
RADIO EQUIPMENT
AN/ARC-5

PUBLISHED BY DIRECTION OF THE CHIEF OF THE BUREAU OF NAVAL WEAPONS

1 October 1949

TABLE OF CONTENTS

SECTION I INTRODUCTION

- 1--1. PURPOSE OF BENCH MAINTENANCE PROCEDURE.
- 1--4. DESCRIPTION OF PROCEDURE.
- 1--6. USE OF THE PROCEDURE.
- 1--11. GENERAL DESCRIPTION OF AN/ARC-5 EQUIPMENT.
- 1--14. TEST EQUIPMENT.

SECTION II PERFORMANCE CHECKS

- 2--1. GENERAL.
- 2--4. RECEIVER CHECKS.
- 2--9. BAND NOISE.
- 2--12. SENSITIVITY.
- 2--15. SELECTIVITY.
- 2--17. AVC CHARACTERISTICS.
- 2--21. TRANSMITTER CHECKS.
- 2--26. TRANSMITTER TRACKING AND LOADING.
- 2--29. MODULATION CHECK.

SECTION III ALIGNMENT PROCEDURE

- 3--1. RECEIVER ALIGNMENT.
- 3--6. TRANSMITTER ALIGNMENT.

SECTION IV TROUBLE ISOLATION

- 4--1. RADIO RECEIVER.
- 4--4. AUDIO-FREQUENCY CIRCUIT.
- 4--6. INTERMEDIATE-FREQUENCY CIRCUIT.
- 4--8. CONVERTER CIRCUIT. (Follow chart below).
- 4--10. RADIO-FREQUENCY CIRCUIT.
- 4--11. ANTENNA CIRCUIT.
- 4--12. TRANSMITTER AND MODULATOR.
- 4--15. OSCILLATOR.
- 4--16. FINAL AMPLIFIER.
- 4--17. MODULATOR.

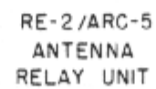
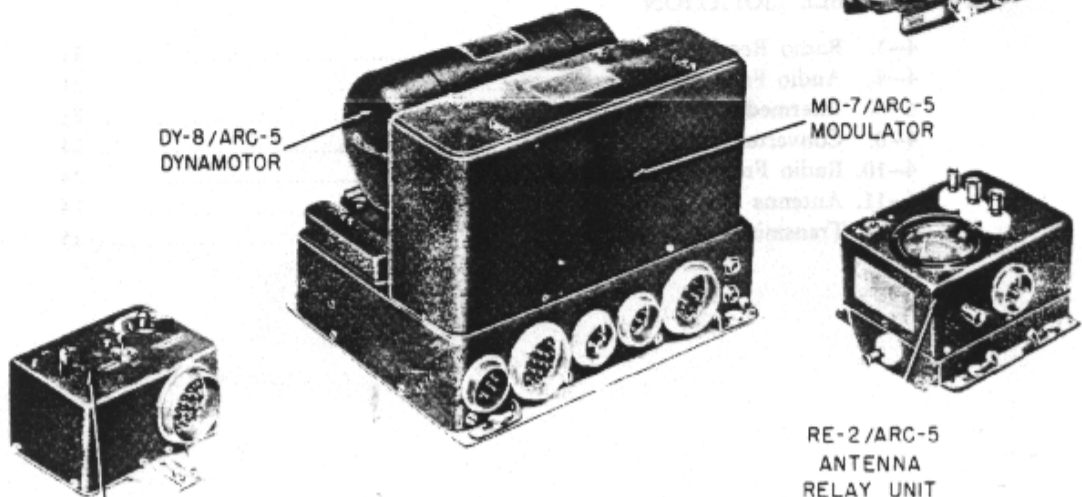
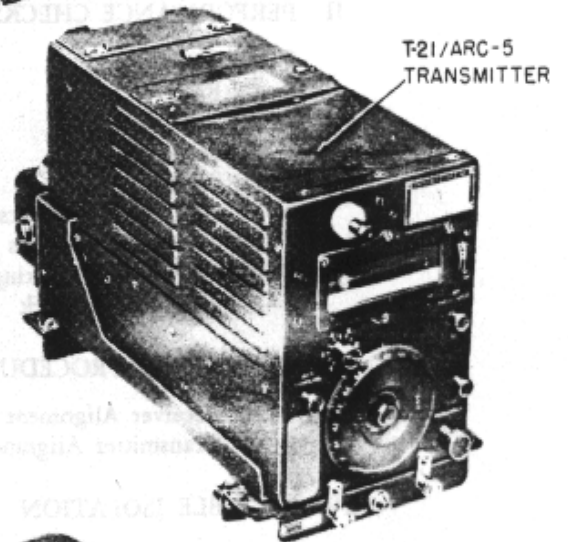
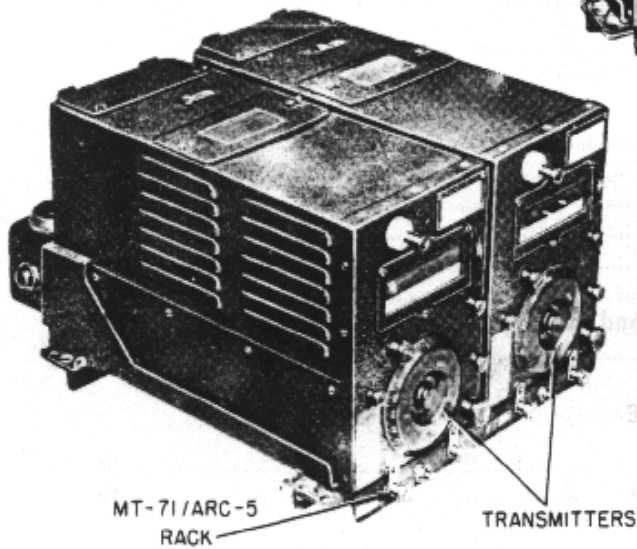
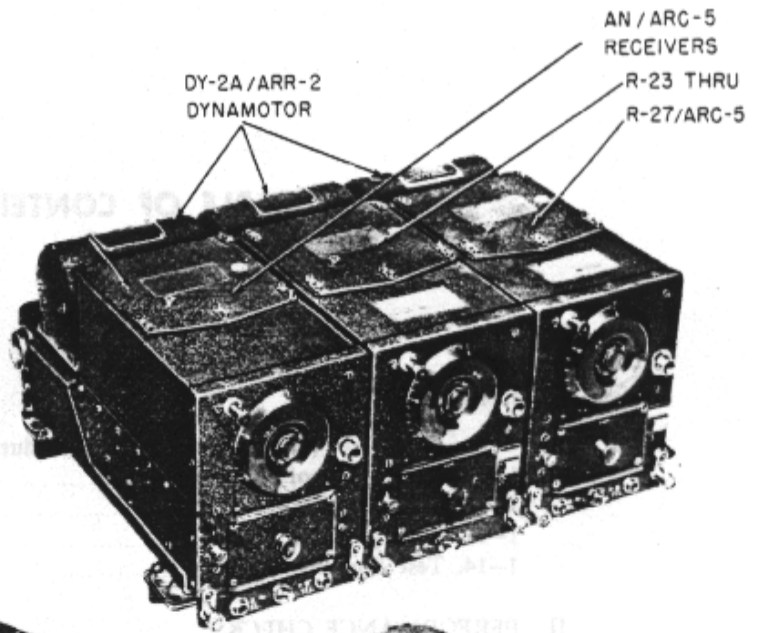
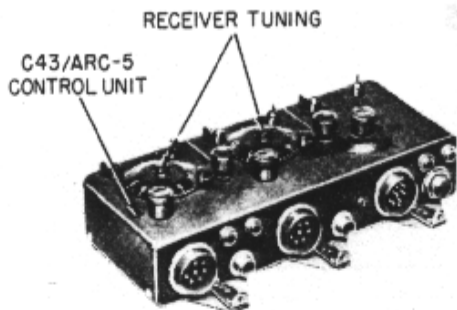

Figure 1-1. AN/ARC-5 Equipment

SECTION I INTRODUCTION

1--1. PURPOSE OF BENCH MAINTENANCE PROCEDURE.

1--2. The basic approach used in the development of this manual has been that of dividing all equipments into two categories:

- a. Components operating at or above a minimum standard of satisfactory performance.
- b. Defective or poorly performing components.

1--3. Bench maintenance is reduced, first, to determining whether or not an equipment is operating satisfactorily, and, second, repairing the equipment if it is found to be defective. This division results in a procedure having four sections:

- a. INTRODUCTION -- This section presents a brief description of the basic function of the subject equipment, its primary power requirements, inter-unit connecting cables, a suggested bench mock-up, and other information necessary for quick reference with respect to proper maintenance techniques.
- b. PERFORMANCE CHECKS -- These are of primary importance and are to be performed in sequence upon the subject equipment. An equipment that meets all the requirements of this series of checks is thereby determined to be satisfactory. An equipment that fails in any one of several of the check requirements is assigned, by means of proper references, to the appropriate steps in one or both of the two sections described below.
- c. ALIGNMENT -- This section details the steps necessary to return the equipment to a properly aligned condition. Practical methods requiring a minimum of maintenance time are employed.
- d. TROUBLE ISOLATION -- This section of the procedure is divided into sections, each of which deals with a specific component, stage or stages according to the function of the equipment. When the maintenance technician is referred to a section of TROUBLE ISOLATION by the failure of the equipment to meet the standards set up in PERFORMANCE, he will find detailed instructions and data pertinent to the function. Additional aids in the form of sectional schematics and suggested testing techniques are at his fingertips. This eliminates time-consuming manual searching, thus increasing the work output and efficiency of the technician.

1--4. DESCRIPTION OF PROCEDURE.

1--5. The procedure begins with a general description of the appearance, function, and operational characteristics of the AN/ARC-5 Communications Equipment. It is followed by a block diagram, list of test equipment and tools, and other necessary information. The procedure proper consists of PERFORMANCE CHECKS, ALIGNMENT, and TROUBLE ISOLATION sections, each of these making use of pictorial diagrams, photographs, and sectional schematics. These aids are related to the written material by means of three types of symbols:

- a. A star-encircled letter indicates a MAJOR CHECK POINT, at which satisfactory PERFORMANCE can be most easily determined.
- b. An encircled numeral indicates SECONDARY CHECK POINT, at which more detailed circuit information such as voltage readings and waveforms, can be obtained for trouble analysis.
- c. C-49 -- Manufacturer's circuit symbols, used to cross-reference all diagrams with the written material.

1--6. USE OF THE PROCEDURE.

1--7. The proper procedure to follow in bench maintenance work is that given by the sequence of the PERFORMANCE CHECKS. These checks follow an order which will most quickly reveal the proper or improper performance of the equipment.

1--8. The failure of the equipment to meet one of these checks suggests the need for ALIGNMENT, or TROUBLE ISOLATION, and appropriate references are made.

1--9. When the reason for defective operation is found and the defect has been corrected, the technician is directed to return to the PERFORMANCE section, repeat the step at which defective operation was first noted, and, if PERFORMANCE is satisfactory, to continue with the remainder of the PERFORMANCE CHECKS.

1--10. Satisfactory completion of the last PERFORMANCE CHECK completes the bench maintenance for the equipment.

1--11. GENERAL DESCRIPTION OF AN/ARC-5 EQUIPMENT.

1--12. The model AN/ARC-5 Aircraft Radio Communication Equipment (See figure 1--1.) is a multi-channel radio transmitter and receiver for use on aircraft having a 22 to 30-volt d-c power supply. The receivers cover a frequency range of 190 kc to 9.1 mc in five independent units, each unit designed to be mounted interchangeably into the receiver racks. Racks are available for either two, and/or three-unit installations, the receivers operating singly or simultaneously, depending upon requirements. Provisions have been made for either local or remote control, but only remote controls are furnished with the equipment. The receiver mounting racks will accommodate other rack types of equipment such as the AN/ARR-2 Receiver and AN/ARC-5 VHF Transmitter-Receiver. These units will not be covered in this procedure. The weight of the equipment, less cables and mechanical linkages, is 23.6 pounds for a two-receiver installation and 55.2 for a three-receiver installation.

1--13. The receivers are designed for the reception of CW, MCW or VOICE modulation. Manual gain control is employed in conjunction with high level automatic gain control. The outputs of each receiver may be paralleled on one line to a single headset, or divided for double headset reception by more than one operator. A 600-ohm headset is to be used with this equipment. A single antenna is used for all receivers and transmitters. The tuning dials are calibrated directly in mc and their accuracy is better than 0.5 per cent. The transmitters cover the frequency range of 2.1 to 9.1 mc in five independent units. They are designed to be installed in pairs. The transmitter frequency control dial is calibrated in megacycles with an accuracy of .03 per cent or better. A crystal calibrator is used in conjunction with an electron resonance indicator to spot-check the dial calibrations of each unit. The current drain from the d-c power source is 8.8 amperes when transmitting with CW emission, and is reduced to 2.5 amperes on "stand-by". The carrier power output varies between eight watts with VOICE modulation to

25 watts with CW emission.

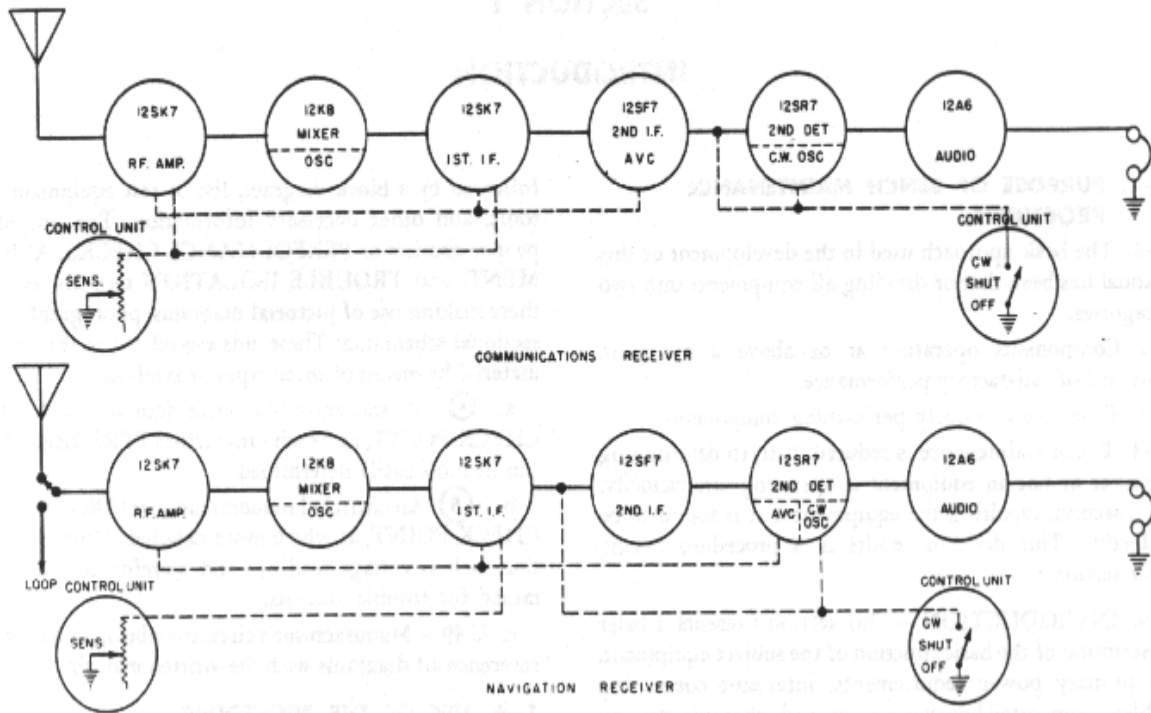

RECEIVER BLOCK DIAGRAM

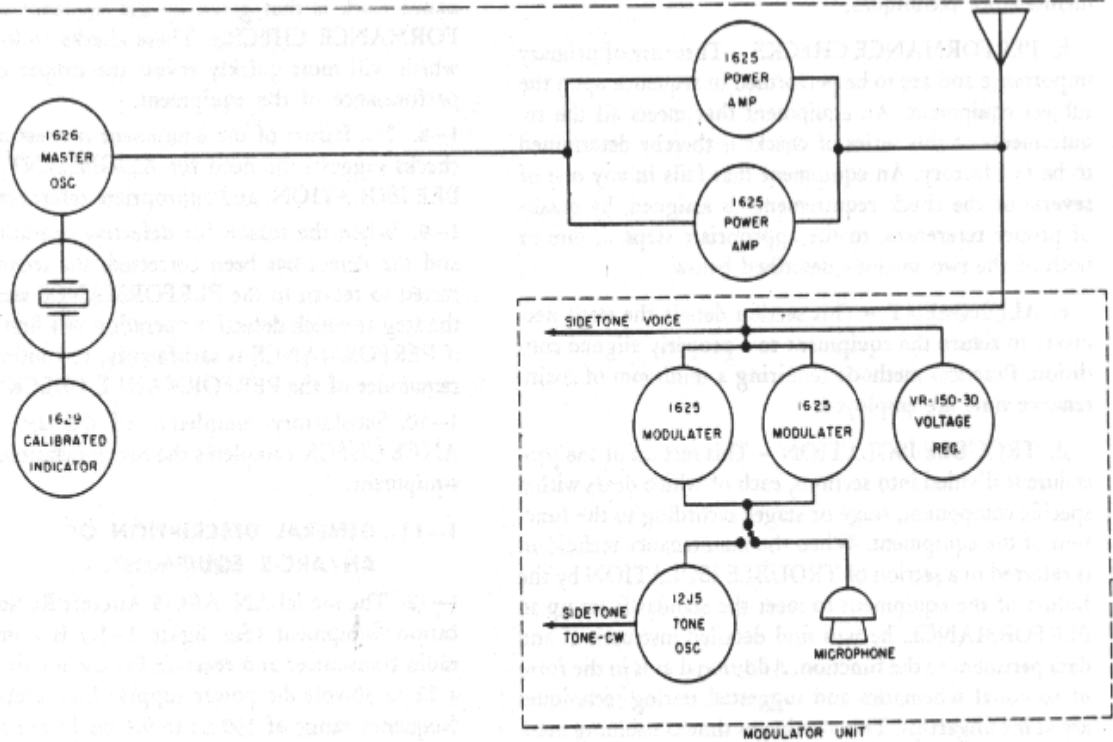

TRANSMITTER BLOCK DIAGRAM

Figure 1-2. Receiver and Transmitter Block Diagrams

1--14. TEST EQUIPMENT.

	DESCRIPTION	RECOMMENDED STANDARD	ALTERNATE
1.	Bench Test Set	AN/GRM-1	AN/ARC-5 TEST BENCH HARNESS Stock No. RI6-R-1047-25
2.	Frequency Meter	LM-13	LM Series
3.	RF Signal Generator	TS-413/U	LP-5
4.	Audio Signal Generator	TS-382A/U	HP-200C
5.	Output Meter	Weston 695	Daven OP-182
6.	Voltmeter	TS-352/U	Simpson 260
7.	VTVM	TS-375/U	RCP 662 or RCA Voltohmyst 165
8.	Oscilloscope	TS 239/UP	Dumont 241
9.	Tube Tester	Hickok 547	Hickok 545 or 540

1--15. One additional extension cable will be required for the bench test setup to record modulation wave forms in TROUBLE ISOLATION. It should be a two-conductor cable about six inches long attached to terminals 10 and 17 of plug 6962 (the plug that fits into modulator receptacle (J-77)). The other end of the two wire extension cable is terminated in two insulated phone-tip jacks, properly identified as terminals I0 and 17 respectively.

Note

If the AN/ARC-5/ARR-2A Test Bench Harness, ASO stock No. R16-R-1047-25, is used in place of the AN/GRM-1, there will be an individual meter for each of the switch positions of the I-104-A and the TS-58/GRM-1. The chart below shows the corresponding meter for each of the switch positions on the I-104-A and the TS-58/GRM-1.

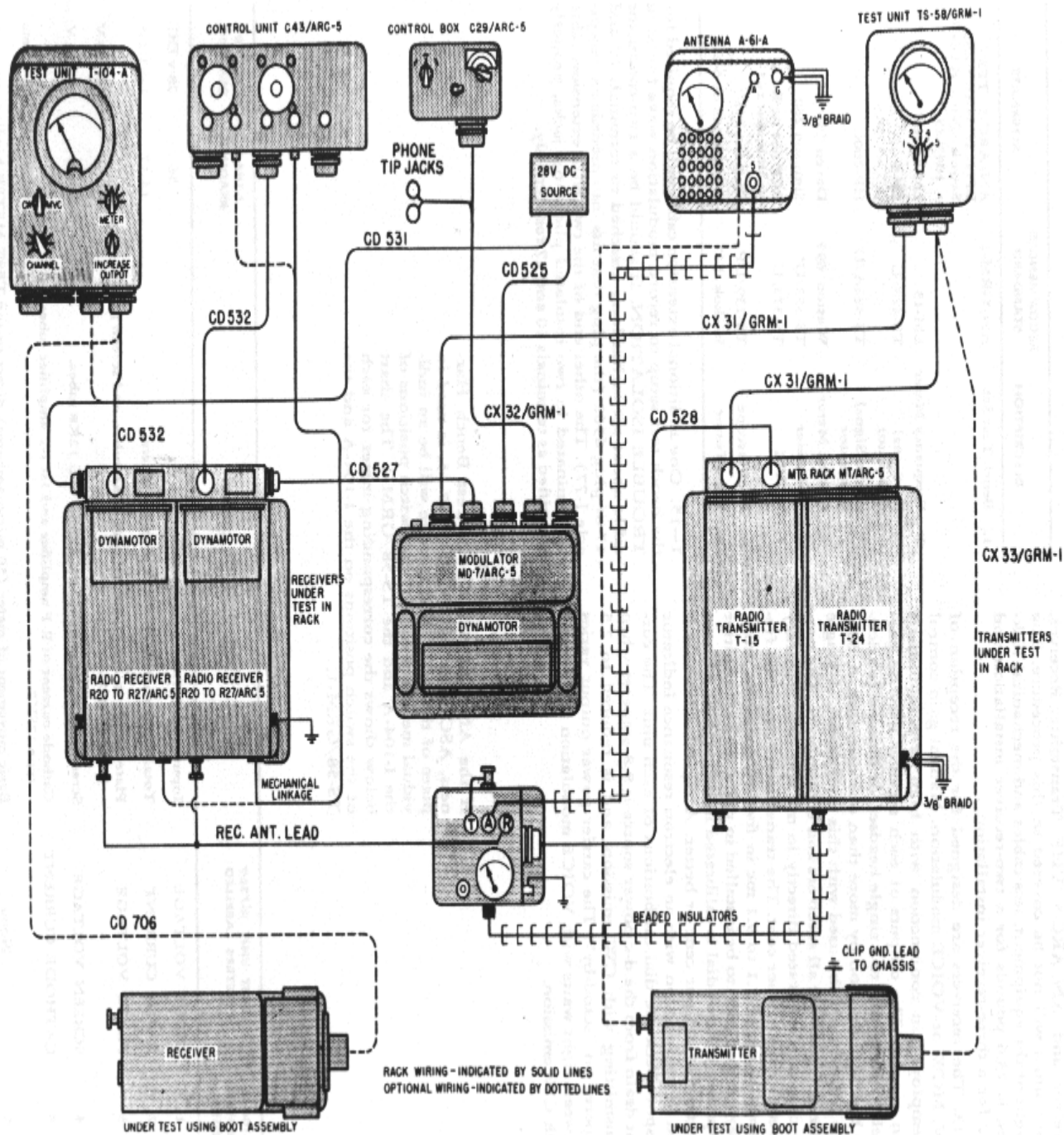

Figure 1-3. Test Equipment Diagram

I-104-A SWITCH POSITION	TEST UNIT #7369 METERS LABELLED	CIRCUIT	I-104-A READING		#7369 READING	
1	INPUT VOLTAGE	Input voltage from primary source.	56		28 V DC	
2	INPUT CURRENT	Total input current from the primary source.	14-17		1.4-1.7 A	
3	PLATE VOLTAGE	Plate supply to 12SF7, 12SK7, and 12K8 tubes, and screen grid voltage on 12A6 tube.	46-50		230-250 V	
4	SCREEN VOLTAGE	Screen grid voltage to 12SF7, 12SK7 and 12K8 tubes.	38-50		76-100 V	
5	CATHODE CURRENT	Cathode current of R-F amplifier and 1st I-F amplifier tubes, type 12SK7s.	44-60		11-15 ma	
6	None	Basic movement of meter (50 micro-amperes) direct to-and-TEST METER binding posts on front panel of I-104-A. I-104-A. Insert jumper wire between these two posts to protect the meter movement.				

TS-58/GRM-1 SWITCH POSITION	TEST UNIT #9556 METERS LABELLED	CIRCUIT	TS-58/GRM-1 READING		#9556 READING	
			TONE	CW	TONE	CW
1	INPUT VOLTAGE	Input voltage from primary source	54	54	27	27
2	SCREEN VOLTAGE	Screen grid voltage to PA tubes	28-31	48-60	140-155	240-300
3	PLATE VOLTAGE	Plate voltage to final PA tubes	51-56	51-55	510-550	510-550
4	OSC. PLATE CURRENT	Plate current of master oscillator tube, type 1626	32-46	32-46	16-23	16-23 ma
5	AMP. PLATE CURRENT	Plate current of final PA tubes type 1625	27-40	60-80	68-100	150-200 ma

TEST SET COMPONENTS

QTY	DESIGNATION	TYPE		USE
		ARMY	NAVY	
1	Antenna	A-61-A		Phantom antenna (LF, MF, HF radio transmitter)
1	ANT. Relay Unit	BC-442-A	RE-2/ARC-5	Antenna relay (LF, MF, HF radio transmitter)
1	Control Unit		C-29/ARC-5	Transmitter control (or C-30A/ARC-5)
1	" "		C-43/ARC-5	Receiver control
3	" "	MC-237		Local tuning crank
1	Cord	CD-525		DC Outlet to modulator
2	"	CD-527		6-Conductor
1	"	CD-528		5-Conductor
2	"	CD-531		DC Outlet to receiver rack (2-Conductor)
2	"	CD-532		8-conductor
1	"	CD-706		Receiver Rack adapter (7-Conductor)
1	"	CD-905		Sidetone test
2	"		CX-31/GRM-1	12-Conductor
1	"		CX-32/GRM-1	18-Conductor
1	"		CX-33/GRM-1	Transmitter rack adapter (7-Conductor)
6	Diagram			Instructions for test equipment AN/GRM-1
1	Dynamotor	DM-33-A	DY-8/ARC-5	Dynamotor (transmitting)
1	Modulator		MD-7/ARC-5	Modulator equipped with tubes
1	Mounting Base	FT-279-A	MT-62/ARC-5	Mounting for MT-63/ARC-5 or FT-277-A Receiver rack

1	"	FT-227-A	MT-70/ARC-5	Mounting for MT-71/ARC-5 Radio transmitter rack
1	"	FT-225-A	MT-76/ARC-5	Mounting (modulator)
1	"	FT-229-A	MT-77/ARC-5	Mounting (antenna relay unit)
1	Mounting Plate	FT-228-A	MT-80/ARC-5	Mounting (transmitter control C-29/ARC-5 or C-50A/ARC-5)
1	"	FT-222-A	MT-98/ARC-5	Mounting (Receiver control C- 43/ARC-5)
1	Mounting Rack	FT-277-A	MT-63/ARC-5	Rack for two radio receivers
1	"		MT-71/ARC-5	Rack for two radio transmitters
1	Test Unit	I-104-A		Test unit for radio receivers
1	"	TS- 58/GRM-1		Test unit for radio transmitters
1	Cord	CD-307-A		Headset extension cord
1	Microphone		RS-38A	Microphone
1	Headset	HS-33		600-ohm headset (two ANB- H-1 receivers or equivalent)

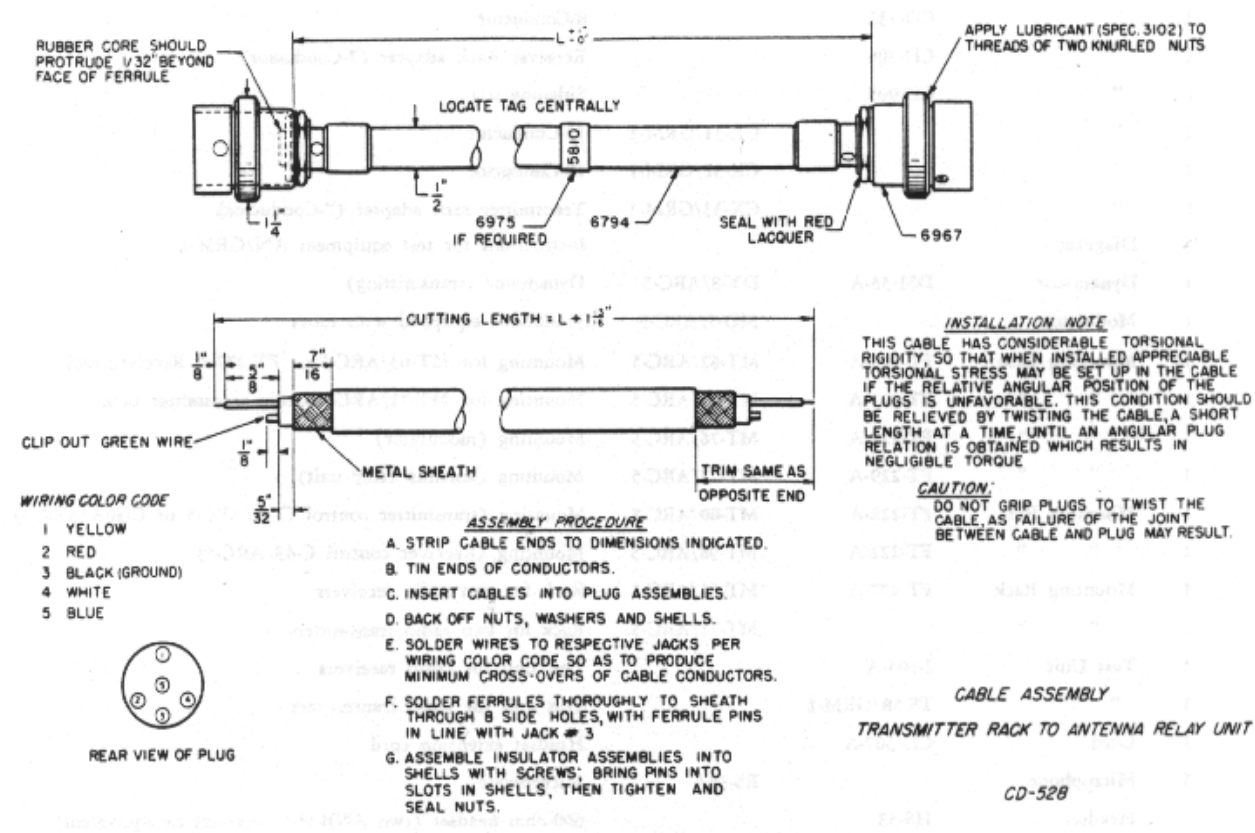
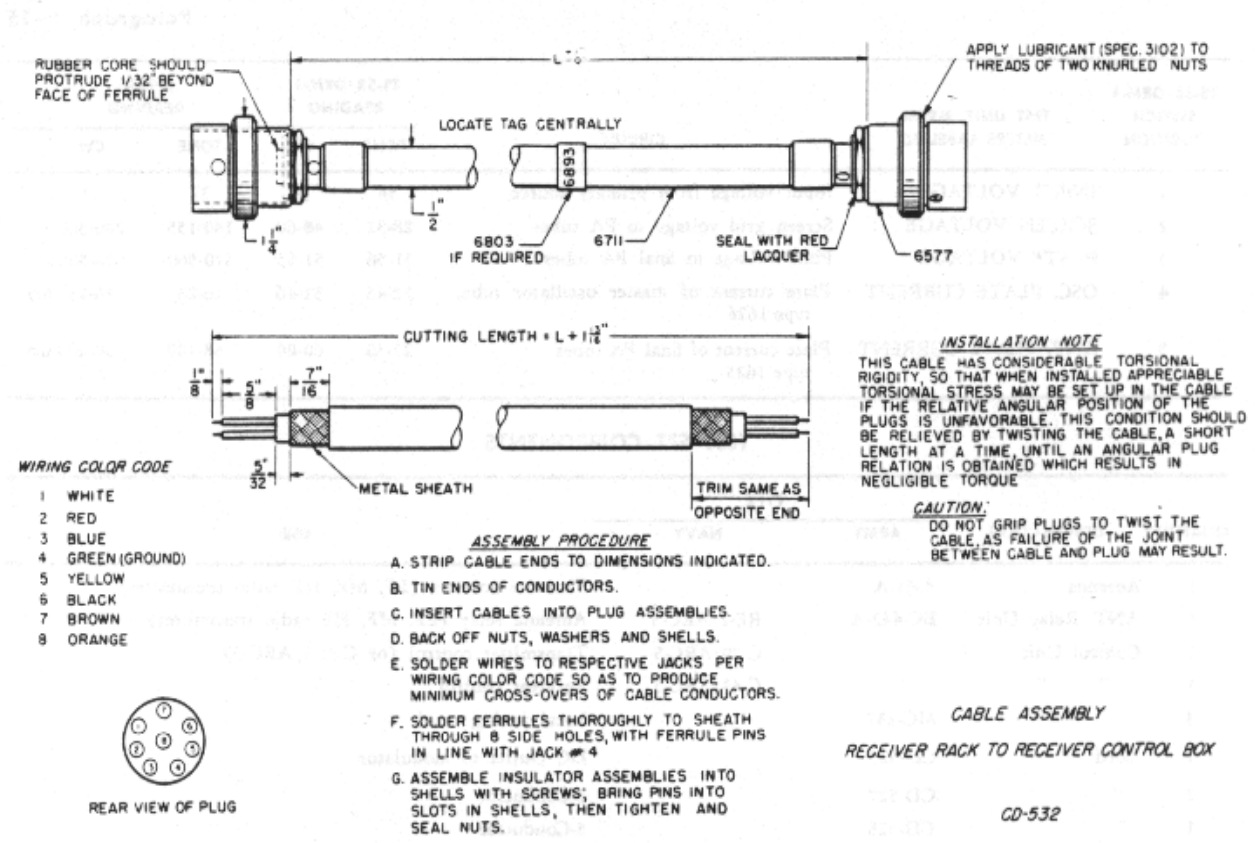
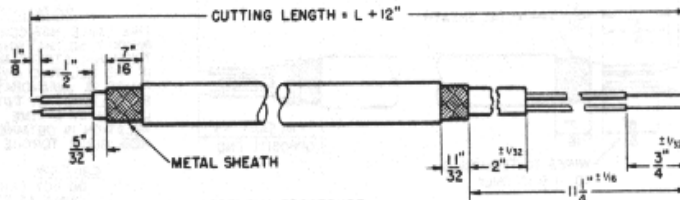
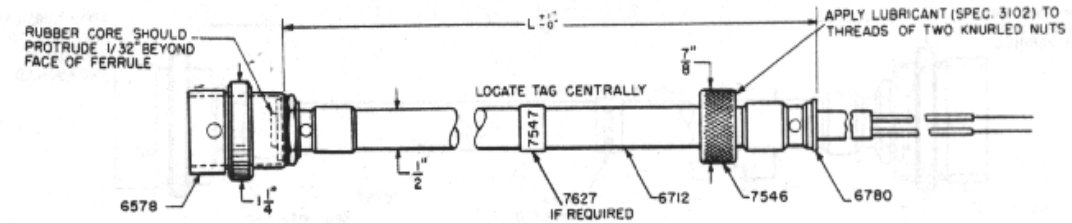

Figure 1-4. Cable Assemblies CD 532 and CD 528



WIRING COLOR CODE

- 1 WHITE
- 2 BLACK (GROUND)
- 3 JUMPER



REAR VIEW OF PLUG

ASSEMBLY PROCEDURE

- A. STRIP CABLE ENDS TO DIMENSIONS INDICATED.
- B. TIN ENDS OF CONDUCTORS.
- C. INSERT CABLES INTO PLUG ASSEMBLIES.
- D. BACK OFF NUTS, WASHERS AND SHELLS.
- E. SOLDER WIRES TO RESPECTIVE JACKS PER WIRING COLOR CODE SO AS TO PRODUCE MINIMUM CROSS-OVERS OF CABLE CONDUCTORS.
- F. SOLDER FERRULES THOROUGHLY TO SHEATH THROUGH B SIDE HOLES, WITH FERRULE PINS IN LINE WITH JACK # 2
- G. ASSEMBLE INSULATOR ASSEMBLIES INTO SHELLS WITH SCREWS; BRING PINS INTO SLOTS IN SHELLS, THEN TIGHTEN AND SEAL NUTS.

CABLE ASSEMBLY

PRIMARY POWER SUPPLY TO RECEIVER RACK

CD-531

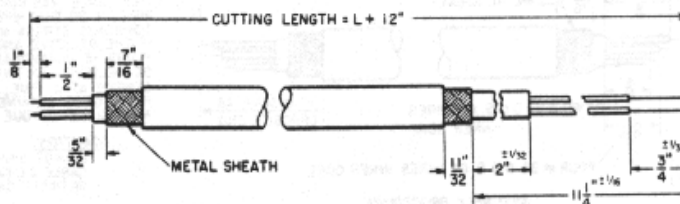
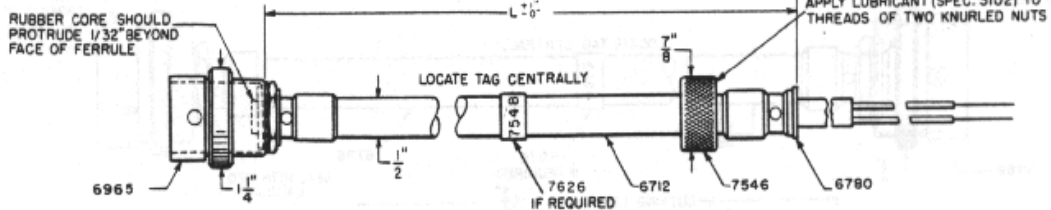

WIRING COLOR CODE

- 1 WHITE B JUMPER
- 2 BLACK (GROUND)
- 3 JUMPER



REAR VIEW OF PLUG

ASSEMBLY PROCEDURE

- A. STRIP CABLE ENDS TO DIMENSIONS INDICATED.
- B. TIN ENDS OF CONDUCTORS.
- C. INSERT CABLES INTO PLUG ASSEMBLIES.
- D. BACK OFF NUTS, WASHERS AND SHELLS.
- E. SOLDER WIRES TO RESPECTIVE JACKS PER WIRING COLOR CODE SO AS TO PRODUCE MINIMUM CROSS-OVERS OF CABLE CONDUCTORS.
- F. SOLDER FERRULES THOROUGHLY TO SHEATH THROUGH B SIDE HOLES, WITH FERRULE PINS IN LINE WITH JACK # 2
- G. ASSEMBLE INSULATOR ASSEMBLIES INTO SHELLS WITH SCREWS; BRING PINS INTO SLOTS IN SHELLS, THEN TIGHTEN AND SEAL NUTS.

CABLE ASSEMBLY

PRIMARY POWER SUPPLY TO MODULATOR UNIT

CD-525

Figure 1-5. Cable Assemblies CD 531 and CD 525

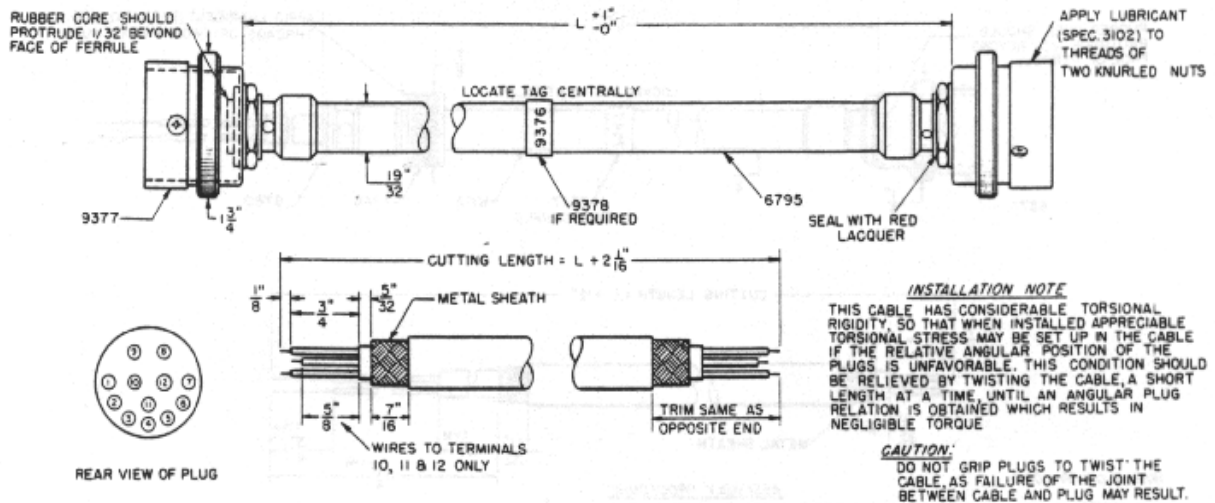

- WIRING COLOR CODE**
- OUTER WHITE
 - OUTER BLACK
 - RED
 - INNER LARGE WHITE
 - INNER LARGE BLACK (GROUND)
 - BLUE
 - GREEN
 - YELLOW
 - BROWN
 - ORANGE
 - INNER SMALL WHITE
 - INNER SMALL BLACK

- ASSEMBLY PROCEDURE**
- STRIP CABLE ENDS TO DIMENSIONS INDICATED.
 - TIN ENDS OF CONDUCTORS.
 - INSERT CABLES INTO PLUG ASSEMBLIES.
 - BACK OFF NUTS, WASHERS AND SHELLS.
 - SOLDER WIRES TO RESPECTIVE JACKS PER WIRING COLOR CODE SO AS TO PRODUCE MINIMUM CROSS-OVERS OF CABLE CONDUCTORS.
 - SOLDER FERRULES THOROUGHLY TO SHEATH THROUGH 8 SIDE HOLES, WITH FERRULE PINS IN LINE WITH JACKS
 - ASSEMBLE INSULATOR ASSEMBLIES INTO SHELLS WITH SCREWS; BRING PINS INTO SLOTS IN SHELLS, THEN TIGHTEN AND SEAL NUTS.

CABLE ASSEMBLY

MODULATOR UNIT TO TRANSMITTER RACK

CX-31/GRM-1

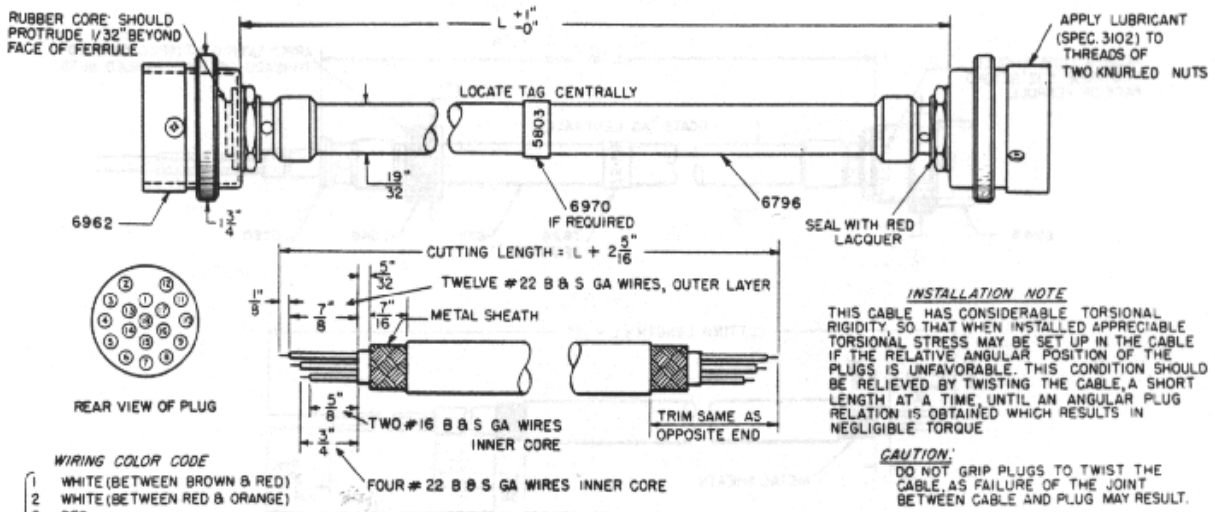

- WIRING COLOR CODE**
- | | | |
|-------------|----|---------------------------------|
| OUTER LAYER | 1 | WHITE (BETWEEN BROWN & RED) |
| | 2 | WHITE (BETWEEN RED & ORANGE) |
| | 3 | RED |
| | 4 | GREEN |
| | 5 | WHITE (BETWEEN ORANGE & YELLOW) |
| | 6 | BLUE |
| | 7 | WHITE (BETWEEN GREEN & YELLOW) |
| | 8 | ORANGE |
| | 9 | WHITE (BETWEEN BLUE & GREEN) |
| | 10 | YELLOW |
| | 11 | BROWN |
| | 12 | WHITE (BETWEEN BROWN & BLUE) |
| INNER CORE | 13 | YELLOW |
| | 14 | BLUE |
| | 15 | BLACK (#16 B & S GA.) |
| | 16 | GREEN |
| | 17 | RED |
| | 18 | WHITE (#16 B & S GA.) |
- (#7 GROUNDED BY SCREW)

- ASSEMBLY PROCEDURE**
- STRIP CABLE ENDS TO DIMENSIONS INDICATED.
 - TIN ENDS OF CONDUCTORS.
 - INSERT CABLES INTO PLUG ASSEMBLIES.
 - BACK OFF NUTS, WASHERS AND SHELLS.
 - SOLDER WIRES TO RESPECTIVE JACKS PER WIRING COLOR CODE SO AS TO PRODUCE MINIMUM CROSS-OVERS OF CABLE CONDUCTORS.
 - SOLDER FERRULES THOROUGHLY TO SHEATH THROUGH 8 SIDE HOLES, WITH FERRULE PINS IN LINE WITH JACK # 7
 - ASSEMBLE INSULATOR ASSEMBLIES INTO SHELLS WITH SCREWS; BRING PINS INTO SLOTS IN SHELLS, THEN TIGHTEN AND SEAL NUTS.

CABLE ASSEMBLY

MODULATOR UNIT TO TRANSMITTER CONTROL BOX

CS-32/GRM-1

Figure 1-64. Cable Assemblies CX-31/GRM-1 and CS-32/GRM-1

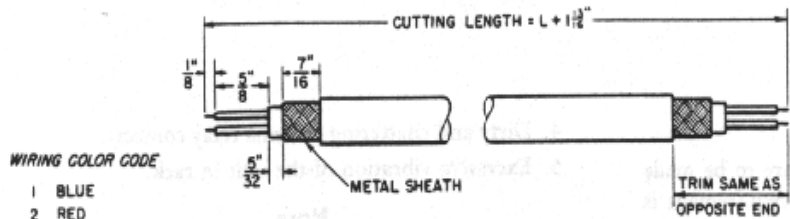
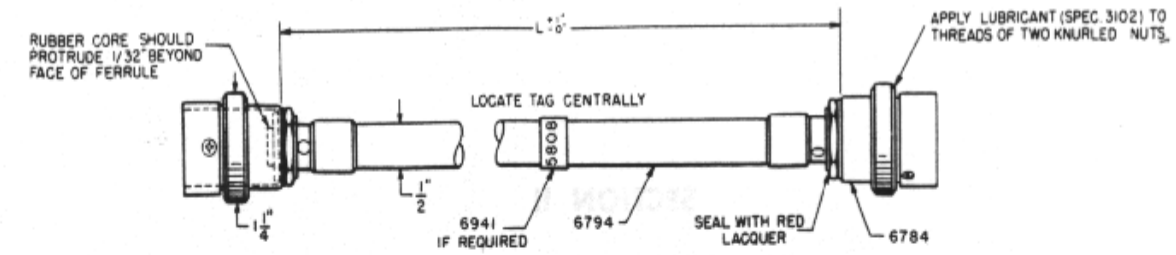

WIRING COLOR CODE

- 1 BLUE
- 2 RED
- 3 BLACK (GROUND)
- 4 GREEN
- 5 YELLOW
- 6 WHITE



REAR VIEW OF PLUG

ASSEMBLY PROCEDURE

- A. STRIP CABLE ENDS TO DIMENSIONS INDICATED.
- B. TIN ENDS OF CONDUCTORS.
- C. INSERT CABLES INTO PLUG ASSEMBLIES.
- D. BACK OFF NUTS, WASHERS AND SHELLS.
- E. SOLDER WIRES TO RESPECTIVE JACKS PER WIRING COLOR CODE SO AS TO PRODUCE MINIMUM CROSS-OVERS OF CABLE CONDUCTORS.
- F. SOLDER FERRULES THOROUGHLY TO SHEATH THROUGH 8 SIDE HOLES, WITH FERRULE PINS IN LINE WITH JACK # 3
- G. ASSEMBLE INSULATOR ASSEMBLIES INTO SHELLS WITH SCREWS; BRING PINS INTO SLOTS IN SHELLS, THEN TIGHTEN AND SEAL NUTS.

INSTALLATION NOTE

THIS CABLE HAS CONSIDERABLE TORSIONAL RIGIDITY, SO THAT WHEN INSTALLED APPRECIABLE TORSIONAL STRESS MAY BE SET UP IN THE CABLE IF THE RELATIVE ANGULAR POSITION OF THE PLUGS IS UNFAVORABLE. THIS CONDITION SHOULD BE RELIEVED BY TWISTING THE CABLE, A SHORT LENGTH AT A TIME, UNTIL AN ANGULAR PLUG RELATION IS OBTAINED WHICH RESULTS IN NEGLIGIBLE TORQUE

CAUTION:

DO NOT GRIP PLUGS TO TWIST THE CABLE, AS FAILURE OF THE JOINT BETWEEN CABLE AND PLUG MAY RESULT.

CABLE ASSEMBLY

MODULATOR UNIT TO RECEIVER RACK

CD-527

Figure 1-74. Cable Assembly CD 527

NOTES

1. If Antenna relay unit RE-2/ARC-5, being tested, does not have a series capacitor, connect the transmitter to "TRANS". Connect "ANT" of the antenna relay unit to terminal "A", instead of to terminal "5", of antenna A-61-A.
2. Test Unit I-104-A normally is used with adapter cord CD-706 as shown. It may be used by attaching cord CD-532 to either position of the receiver rack and when so employed, the meter will not indicate when the meter switch is in position four or five. Volume control on AVC directly affects sidetone level.
3. The drawing shows the mechanical linkage (Part No. 6151) so that the mechanical tuning features of the control units C-26 and C-43/ARC-5 and radio receivers R-20 to R-27/ARC-5 may be tested. No linkage is furnished with the test equipment. Control unit MC-257 (local tuning crank) is furnished for testing these receivers.
4. Test unit I-104-A may be made to function as a control unit and provide the channel selection when testing VHF radio receiver R-28/ARC-5, by connecting cord CD-527 between jack J-103 on the radio receiver and jack J-600 on the test unit.
5. Dynamotors *DY-2/ARR-2 and *DY-2A/ARR-2 are furnished with the particular radio receivers as shown. Both dynamotors are interchangeable with dynamotors DM-32-A or CBY-21531.
6. Transmitters and receivers may be tested either by direct connection to the test equipment, using cords CX-33/GRM-1 and CD-706, or by mounting in a one or two unit rack and using cords CX-31/GRM-1 and CD-532.

SECTION II PERFORMANCE CHECKS

2--1. GENERAL.

2--2. These PERFORMANCE CHECKS are to be made in the order given; when a performance requirement is not met, a reference is made to the appropriate voltage measurement or signal tracing procedure in TROUBLE ISOLATION. ALIGNMENT PROCEDURES are included, but are to be used only as directed in TROUBLE ISOLATION. Signal tracing techniques are used after voltage readings have been found to be normal. The standard maintenance manual should be referred to for detailed information concerning the AN/ARC-5 Equipment.

Note

Receiver and transmitter PERFORMANCE CHECKS are divided as shown in the TABLE OF CONTENTS.

2--3. VISUAL CHECKS. Connect the unit to be checked on the Test Set AN/GRM-1 rack and inspect the unit for the following:

1. Faulty plugs, threads and pins.
2. Improper fusing.
3. Note evidence of excessive dynamotor ripple at the headset while tuning through the frequency band.
4. Dirty and chattering antenna relay contacts.
5. Excessive vibration of the unit in rack.

Note

Open filaments can sometimes be detected by noting cold tubes.

2--4. RECEIVER CHECKS.

2--5. D-C POWER SUPPLY AND OPERATING VOLTAGES.

2--6. LIMITS: Input voltage is 27.5 volts dc at 1.7 amps.
Secondary voltage is 230-250 volts dc at 60 ma.

2--7. PRELIMINARY INSTRUCTIONS: Use Test Set AN/GRM-1, as shown in figure 1-3.

Use "Optional Wiring" for greater ease in maintenance testing. Do not key the transmitter. Apply d-c power and turn the CONTROL SWITCH of Test Set I-104-A to MCW position, allowing the equipment time to warm up. Do not remove the cover plates until trouble isolation or alignment is indicated by performance failure. Advance INCREASE OUTPUT control to full clockwise position.

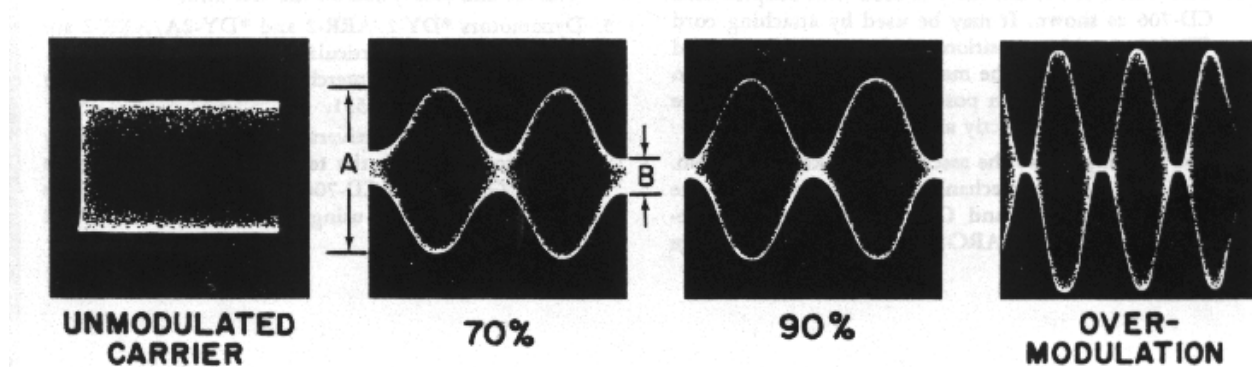

Figure 2-1. Modulation Envelopes

2--8. TEST PROCEDURE.

STEP	HEAD TEST SET	METER SW	CIRCUIT MEASURED	NORMAL VALUES	NORMAL METER INDIC.	ABNORMAL METER INDIC.
1	I-104-A	1	Input voltage	27.5 v	56	Refer to TROUBLE ISOLATION PROCEDURE, Section IV, Paragraph 4-1.
2	I-104-A	2	Input current	1.4-1.7 a	14-17	
3	I-104-A	3	Plate supply	230-250 v	46-50	
4	I-104-A	4	Screen supply	76-100 v	38-50	
5	I-104-A	5	Cathode current RF and 1st IF tubes	11-15 ma	44-60	

2--9. BAND NOISE.

2--10. LIMITS: (Less than 15 milliwatts.)

2--11. TEST PROCEDURE.

STEP	TEST SET I-104-A	NORMAL OUTPUT INDICATION AND CONNECTIONS	POSSIBLE CAUSES OF ABNORMAL IND.
1	CONTROL SWITCH to CW or MCW. INCREASE OUTPUT control to maximum. Connect dummy antenna (100 mmfd capacitor) from Antenna post to ground. Use short leads.	Output Meter, OP-182, and headphones connected to headset jack of 1-104-A. Switch set to 600 ohms.	
2	Peak receiver ALIGN INPUT trimmer for maximum output at the high frequency end of dial.	Reads less than 1.5 mw of noise.	Check dynamotor brushes and bearings. Replace dynamotor, if necessary.
3	Turn the receiver frequency dial from high to the low end and note the maximum noise in the output meter.	Never exceed 1.5 mw.	Same.

2--12. SENSITIVITY.

2--13. LIMITS. Less than 10 uv R-F input to obtain 10 mw audio output with INCREASE OUTPUT control set at maximum.

2--14. TEST PROCEDURE.

STEP	RECEIVER SETTINGS	SIG. GEN CONNECTIONS	OUTPUT INDIC. & CONNECTIONS	NORMAL INDICATION	POSSIBLE CAUSES OF ABNORMAL IND.
1	FREQUENCY at high end; MCW operation: INCREASE OUTPUT control at maximum.	Through .006 mfd capacitor, to receiver Antenna post. Set frequency to agree with receiver.	Output meter, OP-182, and headphones connected to headphone jack. Set switch to 600 ohms.		
	Peak ALIGN INPUT trimmer.	Use modulated RF 30 per cent at 400 or 1000 cycles.	Maximum output.	A peak on output meter.	
2	Same as Step 1.	Vary attenuator to obtain 10 mw receiver output.	Same as Step 1.	10 uv input, or less, to obtain 10 mw audio output.	Refer to TROUBLE ISOLATION, Section IV, paragraphs 4--4 to 4--11, and ALIGNMENT PROCEDURE, Section 3--1.
3	Same as Step 1. except switch to CW. Rock receiver dial carefully for maximum output.	Turn MODULATION switch to OFF. Vary attenuator to obtain 10 mw receiver output.	Same as Step 1.	3.5 uv input to obtain 10 mw output.	Check CW oscillator and ALIGNMENT PROCEDURE, Section III, paragraph 3--1.
4	Repeat Steps 1 through 3 with receiver dial set at low end.				

2--15. SELECTIVITY.

2--16. PRELIMINARY ADJUSTMENTS: Set the Model 695 output meter to the 1.5 volt range. Connect a 300-ohm one-half or one watt composition resistor in parallel with the output meter; connect output meter to receiver phone jack. Set the receiver INCREASE OUTPUT control to full counterclockwise position. Tune the receiver and the signal generator to the proper frequency, as given in Table below. Adjust the signal generator attenuators for 50 microvolts output, 30 per cent modulated at 400 cycles. Advance the INCREASE OUTPUT control clockwise until the Model 695 output meter reads 1.0 volts. The receiver dial and the ALIGN INPUT trimmer should be adjusted for maximum output meter reading. Readjust the INCREASE OUTPUT control as necessary to give output meter reading of 1.0 volts. Receiver should be set for MCW operation.

STEP	OUTPUT METER SETTINGS	SIGNAL GENERATOR SETTINGS
1	Switch output meter to 15 volt range.	Adjust the output attenuators for 500 microvolts output. (Switch MULTIPLIER to 100 position.) Slowly detune FREQUENCY dial higher in frequency until output meter reads less than 6.0 volts.
2	Switch output meter to 6 volt range.	Slowly detune FREQUENCY dial higher in frequency until output meter reads slightly less than 1.5 volts.
3	Switch output meter to 1.5 volt range.	Slowly and carefully detune FREQUENCY dial higher in frequency until output meter reads 1.0 volts.
4		Record the amount of frequency deviation from original setting at resonance, as given in PRELIMINARY ADJUSTMENTS.
5	Repeat Steps 1 through 4.	Repeat Steps 1 through 4, detuning the FREQUENCY dial lower in frequency.
6	Compare values obtained in Steps 4 and 5; they should be very nearly equal in value. Amount of frequency deviation recorded in Steps 4 and should not exceed values given in Table below by more than 10 per cent.	
7	Repeat Steps 1 through 5 on the R-23 (.19-.55 mcs.) receiver, with 50,000 microvolts input, instead of 500. Specifications given in Step 6 also apply.	

RECEIVER	FREQUENCY	FREQUENCY DEVIATION EITHER SIDE OF RESONANCE
R-23 .19-.55 mcs.	.19 mcs.	3.0 kcs. 6.0 kcs.***
R-24 .52-1.5 mcs.	.52 mcs.	5.0 kcs.
R-25 1.5-3.0 mcs.	1.5 mcs.	7.0 kcs.
R-26 3.0-6.0 mcs.	3.0 mcs.	15.0 kcs.
R-27 6.0-9.0 mcs.	6.0 mcs.	28.0 kcs.

*** at 50,000 microvolts input

2--17. AVC CHARACTERISTICS.

2--18. LIMITS:

10X Normal sensitivity -- 50 to 150 mw.

100X Normal sensitivity -- 100 to 200 mw.

1000X Normal sensitivity -- 200 mw.

10000X Normal sensitivity -- 200 to 400 mw.

Note

Normal sensitivity is that setting of the signal generator output necessary to produce 10 mw receiver output.

2--19. PRELIMINARY INSTRUCTIONS. Obtain normal sensitivity before starting this check. This check may be omitted on R-23 and R-24 navigation receivers.

2--20. TEST PROCEDURE.

STEP	SIGNAL GENERATOR CONNECTIONS	OUTPUT INDIC. & CONNECTIONS	NORMAL INDIC.	POSSIBLE CAUSES OF ABNORMAL INDICATION
1	Same as Steps 1 and 2 of SENSITIVITY check.			1. Audio amplification is insufficient. Refer to TROUBLE ISOLATION, Section IV, paragraph 4--4.
2	Increase attenuator setting 1000X the setting at normal sensitivity.	Record reading of output meter.	200 mw indicates that the audio level is sufficient for normal operation.	2. Faulty AVC indicated by a decreasing output with increased signal input.
3	Increase attenuator setting 10000X the setting at normal sensitivity.	Same as Step 1.	200 to 400 mw	Refer to TROUBLE ISOLATION, Section IV, paragraph 4--7.
4	Set attenuator to 100X the setting at normal sensitivity.	Same as Step 1.	100 to 200 mw	
5	Set attenuator to 10X the setting at normal sensitivity.	Same as Step 1.	50 to 150 mw	

2--21. TRANSMITTER CHECKS.

2--22. POWER SUPPLY.

2--23. LIMITS: Input voltage 27.5 v dc.
Secondary voltage 545 v dc.

2--24. PRELIMINARY INSTRUCTIONS: Use Test Set, AN/GRM-1, as shown in figure 1--3. Apply d-c power and allow time for the equipment to warm up. Depress the test key when recording all tests.

2--25. TEST PROCEDURE.

STEP	C-29/ARC-5 CONTROL BOX	OPERATION	TS-58/GRM-1 READS	VOLTMETER VALUES	POSSIBLE CAUSES OF ABNORMAL IND.
1	Select transmitter 1 or 2 corresponding to the rack position of unit. Switch to CW and key transmitter.	Dynamotor runs. Note any evidence of overload in the form of excessive noise or heat.			Refer to TROUBLE ISOLATION, Section IV, paragraph 4--12.
2	Same.	Switch TS-58 to Position 1; read heater voltage.	54 divisions.	27.5 v	
3	Same.	Switch TS-58 to Position 3; read B+.	51-55 divisions.	510-550 v	
4	Switch to VOICE or TONE. Key transmitter.	Same.	51-55 divisions.	510-550 v	

2--26. TRANSMITTER TRACKING AND LOADING.

2--27. LIMIT: Phantom Antenna Plate Current:

	TS-58/GRM-1, pos. 5 Current	
No load (zero coupling)	10	25 ma
Loaded-MCW-VOICE	20-40	50-100 ma
Loaded-CW	60-80	150-200 ma

Frequency Calibration:

Within 0.03% of dial reading at any frequency, except at crystal frequency, where tolerance is 0.05%.

R-F Power Output: CW emission--2.25 amps minimum (25 watts)

VOICE emission--1.61 amps minimum (13 watts) unmod.

TONE emission--1.85 amps minimum (17 watts)

**** Above -- listed values of current measured on the ARC No. 7777 Phantom Antenna R-F current meter.

2--28. TEST PROCEDURE.

STEP	TRANSMITTER CONTROLS	OPERATION	NORMAL INDICATION	ABNORMAL INDICATION
1	Select and switch on transmitter 1 or 2 depending on position in rack. Switch to CW. Unlock all transmitter controls. Set COUPLING and ANT. INDUCTANCE at zero.	Set TS-58/GRM-1 switch to position 5. Set transmitter dial to the lowest frequency. Observe TS-58 GRM-1 meter while tuning transmitter dial throughout its range.	TS-58/GRM-1 meter reading should not exceed 10 through out the range of the transmitter FREQUENCY dial.	Refer to TRANSMITTER ALIGNMENT, Section III, paragraph 3t6. Refer to TROUBLE ISOLATION, Section IV, paragraph 4---16.
2	Set FREQUENCY dial, 100 kc from high end.			
3	Set COUPLING at 3, and key the transmitter.	Vary ANT INDUCTANCE from 0 upward, until antenna current is indicated. Adjust COUPLING and ANT INDUCTANCE carefully for maximum antenna current.	Antenna meter reads 2.0 to 3.0 amps. TS-58/GRM-1, position 5, reads 60.80 (150-200 ma).	Refer to TROUBLE ISOLATION, Section IV, paragraphs 4--15 and 4--16.
4	Switch to VOICE. Key transmitter,	Reduce COUPLING to zero; then advance clockwise until antenna meter reads 1.6 amps.	Antenna meter reads 1.6 amps. TS-58/GRM-1, position 5, reads 20-40 (50-100 ma).	Refer to TROUBLE ISOLATION, Section IV, paragraphs 4--16 and 4--17.
5	Same. Key transmitter,	Loosely couple LM frequency meter to transmitter and adjust it for zero-beat with transmitter frequency.	Frequency as indicated by the LM should be within .03 per cent of the frequency indicated on transmitter dial.	Refer to TRANSMITTER ALIGNMENT, Section III, paragraph 3----6.
6	Repeat Steps 3, 4, and 5 with transmitter dial set at 100 kc from low end of band.			
7	Repeat Steps 3, 4, and 5 with transmitter dial set to the crystal frequency.			
8	Repeat Steps 3, 4, and 5 with transmitter dial set to the operating frequency.			

9	Lock all controls except coupling control.
---	--

2--29. MODULATION CHECK.

2--30. PRELIMINARY INSTRUCTIONS:

Modulation capabilities of the transmitter are determined by use of the oscilloscope, displaying a modulation envelope type of pattern. In addition to the normal oscilloscope control settings, the following should be observed:

Oscilloscope Settings--Vertical input to plates direct. Sync control to EXTERNAL.

Oscilloscope Connections--Sync voltage is obtained from one of the phone jacks in receiver rack or junction box. The vertical input terminal of the oscilloscope is loosely coupled to the transmitter R-F output, by attaching a wire, having good R-F insulation, to the vertical input terminal. The other end of this wire is brought close to the phantom antenna lead from the transmitter. The degree of coupling between these two leads will determine the vertical height of the modulation pattern.

STEP	TRANSMITTER CONTROLS	OPERATION	NORMAL INDICATION	ABNORMAL INDICATION
1	Set emission to TONE. Key transmitter. Adjust COUPLING control for maximum Antenna current.	Adjust sweep frequency controls of scope until two or more audio cycles are displayed. Adjust Sync control for steady pattern.	Sinewave envelope pattern with no appreciable distortion; see figure 2--1. Modulation percentage should be 60 per cent or better as calculated by use of formula below.	Refer to TROUBLE ISOLATION, Section IV, paragraph 4--17.
2	Set emission to VOICE. Key transmitter.	Speak in mike at normal voice level.	Observe that the modulation peaks rise to a higher value than that obtained for normal indication in Step 1.	Refer to TROUBLE ISOLATION, Section IV, paragraph 4--17.

MODULATION FORMULA: $(A-B)/(A+B) * 100 = \% \text{ modulation}$

SUMMARY TEST DATA CHECK OFF SHEET

AN/ARC-5

Antenna Relay _____ Mike Jack _____ Phone Jack _____ Dynamotor Ripple _____

Calibration (.08%) _____ Vibration _____ Align Input _____ Dyn. Overhaul
Date _____

Max. Band Noise .19-.55mc .52-1.5mc 1.5-3.0mc 3.0-6.0mc 6.0-9.1mc
(15 mw) _____ SENSITIVITY HIGH END LOW END

AVC CHARACTERISTICS
(7uv) CW MCW INPUT OUTPUT
RATIO LIMITS

.19-.55mc _____ NOR. SENS. _____ uv. (mw)
.52-1.5mc _____ 5X _____ 50-1001.5-3.0mc
_____ 10X _____ 50-150

3.0-6.0mc _____ 100X _____ 100-200
6.0-9.1mc _____ 1000X _____ 100-300
10000X _____ 200-400 AUDIO OUTPUT CW _____ MCW _____ 200 200

SELECTIVITY
RECEIVER .19-.55mc .52-1.5mc 1.5-3.0mc 3.0-6.0mc 6.0-9.1mc LIMITS
2X _____ 2X -- 2.1-10 kc

10X _____ 10X -- 5-10 kc
10000X _____ 10000X -- 18 kc

TRANSMITTER POWER TRANSMITTER TRANSMITTER TRANSMITTER
OUTPUT FREQUENCY MODULATION TUNE-UP
CW _____

26 to 40 CW _____ VOICE _____ VOICE _____
.05% Approx. 70% Max. ant.

current
TONE _____

13 to 26
VOICE _____ CHANNEL SEL. POWER SUPPLY
13 to 26 1 _____ 2 _____ IN _____ OUT _____
27.5Vdc 545Vdc

SECTION III ALIGNMENT PROCEDURE

3--1. RECEIVER ALIGNMENT.

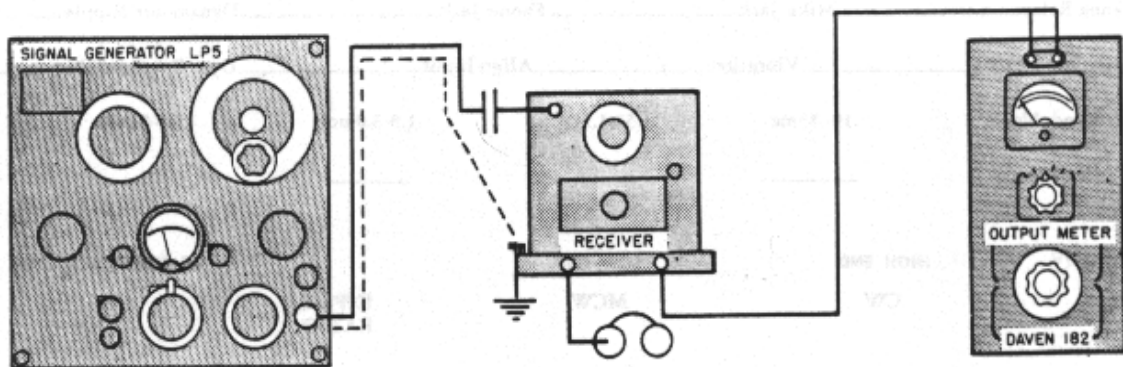

Figure 3-1. Receiver Alignment Connections

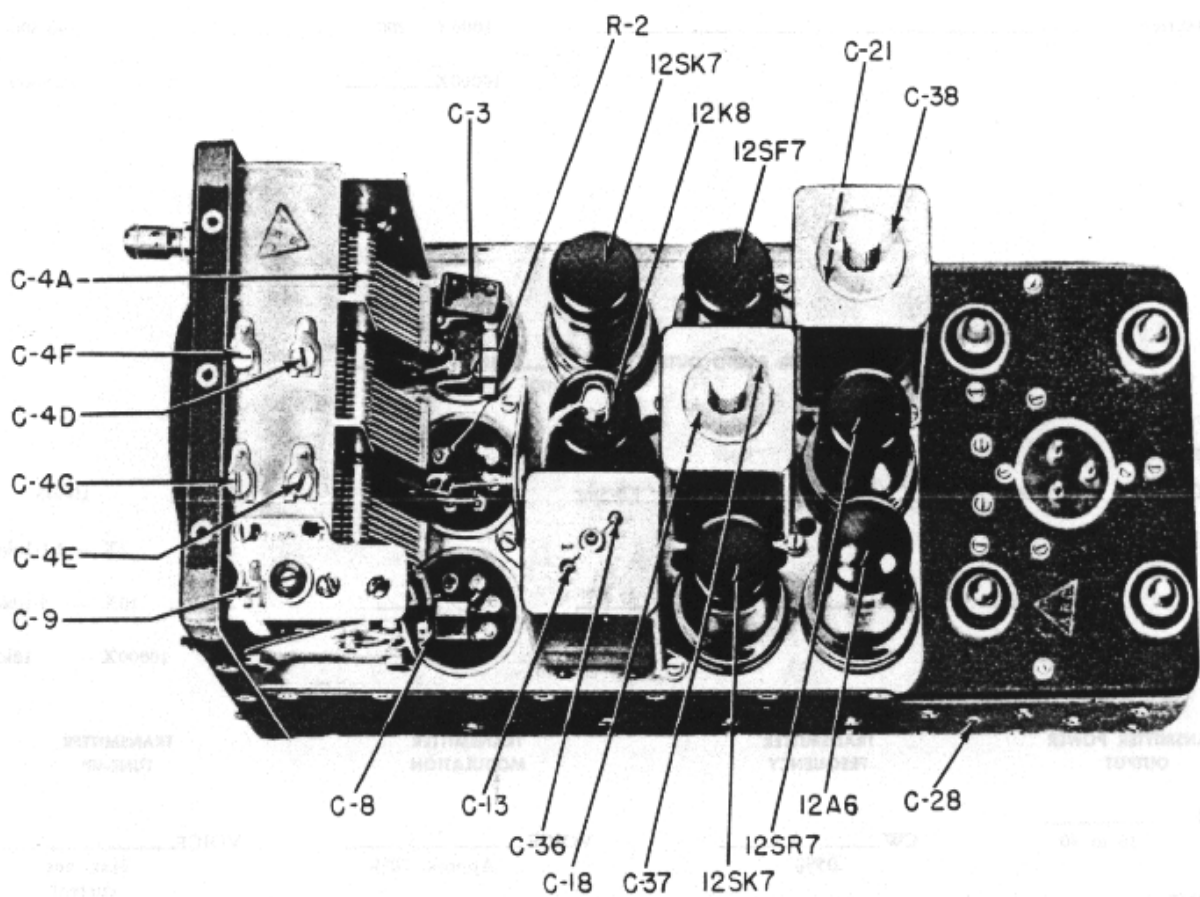

Figure 3-2. Location of Trimmers, Typical Receiver

3--2. PRELIMINARY INSTRUCTIONS. Output Meter--Daven, Model OP-182, connected into headset jack on receiver rack; IMPEDANCE SELECTOR set at 300 ohms.

Signal Generator--LP-5 or Hickok 19X connected between the point indicated on alignment chart and ground. Controls--Set gain control at maximum, emission to MCW, signal generator switch ON, and dial as indicated in chart.

Output Level--During alignment, the signal generator output must be attenuated to maintain the receiver output at 10 mw as indicated by output meter. 3--3. RECEIVER ALIGNMENT NOTES. 3--4. The receivers R-23, R-24 and R-23A normally operate with over-coupled I-F stages. For alignment, each I-F stage must be loosely coupled by pulling out the bakelite rod to the snap-out position. After the entire alignment is completed, the I-F stage must be returned to the same over-coupled condition. For the R-23 and R-24, over-couple the first I-F stage; for the R-23A and R-148, over-couple all I-F stages.

3--5. RECEIVER ALIGNMENT PROCEDURE. (See figures 3--1 and 3--2.) Before beginning alignment, check the positions of C4F and C4G and adjust them if necessary to the position shown in the table which follows. The positions shown are as seen from the FRONT of the receiver.

RECEIVER	C4F	C4G
R-23		
R-24		
R-25		
R-26		
R-27		

Front of Receiver

STEP	SIGNAL GENERATOR		RECEIVER		SPECIAL INSTRUCTIONS	TRIMMERS
	CONNECTIONS TO RECEIVER	FREQUENCY SETTINGS	TYPE	DIAL SETTING		
1	Through .006 mfd capacitor to mixer grid use MOD RF.	85 kc 239 kc 705 kc 1415 kc 2830 kc	R-23 R-24 R-25 R-26 R-27	ANY DIAL SETTING	See Receiver Alignment Note, paragraph 3--3. Adjust all I-F trimmers as indicated at right, for maximum output meter reading.	C-21 C-38 C-37 C-18 C-36 C-13
2	Same Use PURE RF.	Same			Switch receiver to CW and adjust BFO trimmer for zero-beat.	C-28

3	Same Use MOD RF.	.52 mc 1.4 mc 2.9 mc 5.8 mc 8.9 mc	R-23 R-24 R-25 R-26 R-27	.52 mc 1.4 mc 2.9 mc 5.8 mc 8.9 mc	Switch to MCW. Adjust oscillator trimmer for maximum output meter reading.	C-4E
4	Through .006 mfd capacitor to ANT post.	Same		Same	Adjust R-F trimmer and ALIGN INPUT trimmer for maximum output.	C-4D C-2
5	Same	Same		Same	Adjust oscillator trimmer for maximum output.	C-4E
6	Same	.21 mc .57 mc 1.55 mc 3.1 mc 6.1 mc	R-23 R-24 R-25 R-26 R-27	.21 mc .57 mc 1.55 mc 3.1 mc 6.1 mc	Adjust oscillator padder, while carefully rocking the receiver dial, for maximum output.	C-9
7	Repeat Steps 5 and 6 two or more times until there is no further increase in output when Step 5 is performed. Then, proceed with Step 8.					
8	Same Use PURE RF.	Same as Step 5		Same as Step 5	Switch to CW. Adjust oscillator trimmer for zero-beat.	C-4E
9	Return I-F transformers to overcoupled condition: See Receiver Alignment Note, paragraph 3--3.					

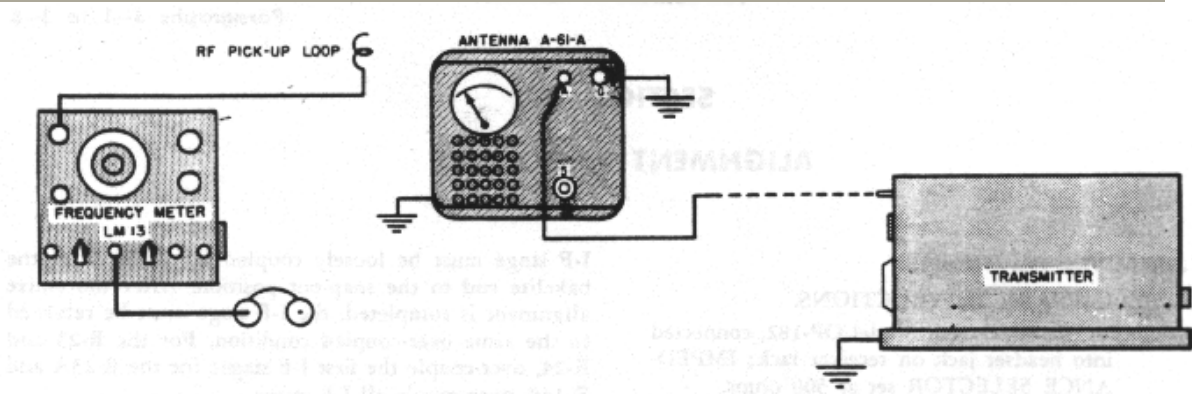

Figure 3-3. Transmitter Alignment Connections)

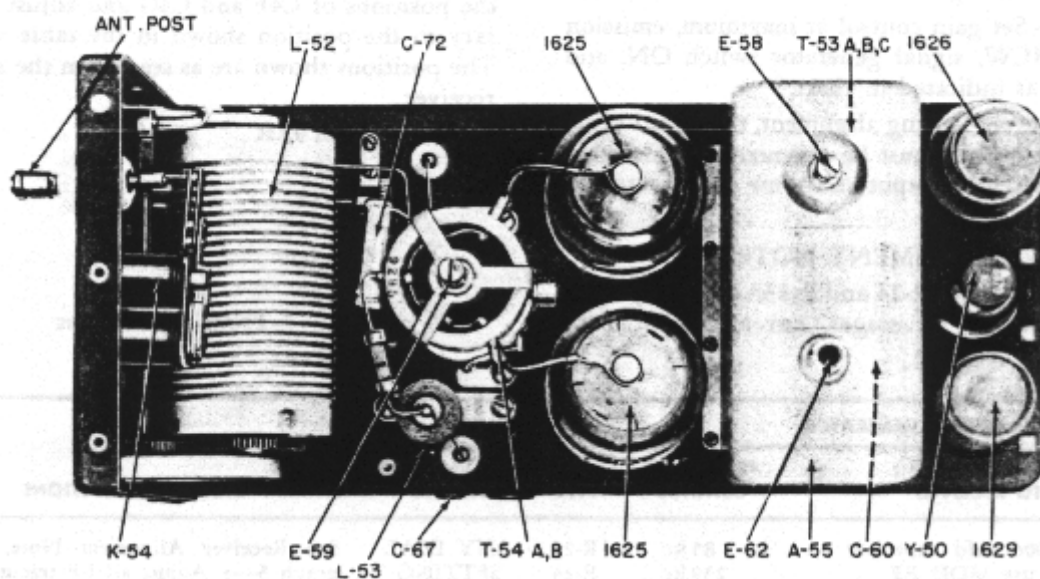

Figure 3-4. Transmitter Adjustment Points (Top)

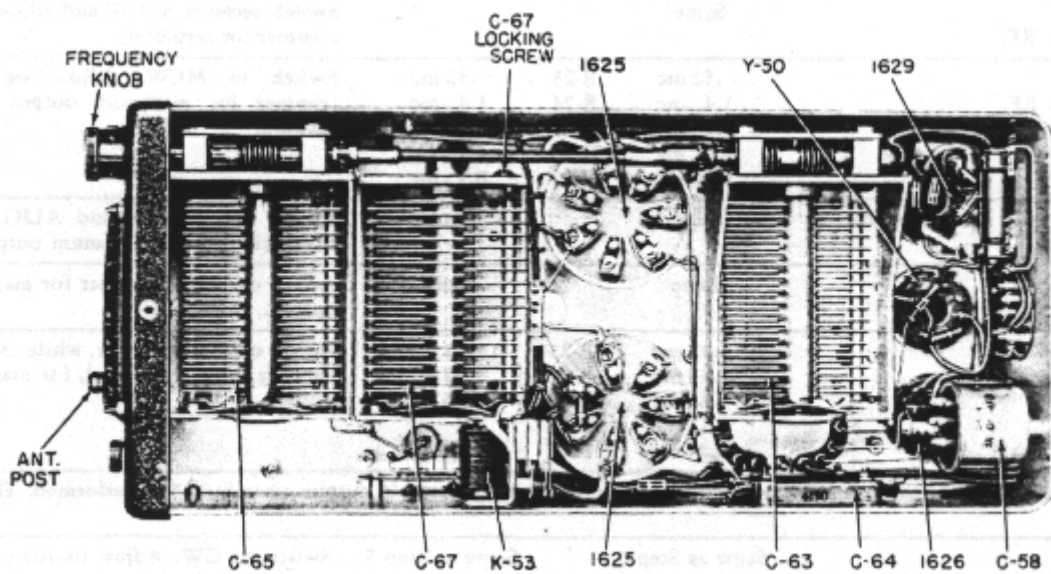

Figure 3-5. Transmitter Adjustment Points (Bottom)

3--6. TRANSMITTER ALIGNMENT.

3--7. PRELIMINARY INSTRUCTIONS.

Bench Setup- Connect transmitter, with outer shield removed, to AN/GRM-1, as shown in figure 1--3. Frequency Meter -- LM-13 -- Couple as indicated in Transmitter Alignment Chart, (See figure 3--3.).

3-8. TRANSMITTER ALIGNMENT NOTES.

3--9. Zero-beat should occur at mid-position of E-62. If it is impossible to obtain a zero-beat with E-62, C-60 may be unlocked from its normal locked position and adjusted to give a zero-beat with E-62 at mid-position.

3-10. To correct frequency error at the low end, transmitter FREQUENCY by over-shooting the correct setting an amount one-half that of the error. Adjust E-58 for zero-beat. Reset FREQUENCY to correct setting and retrim C-60 for zero-beat. The reason for the latter operation is to achieve accuracy at the high and low frequency points with a minimum number of steps.

3-11. To correct the tracking error, E-59 should be adjusted at the low frequency and by over-shooting by one-half the number of turns necessary to obtain minimum plate current. TRANSMITTER ALIGNMENT CHART (See figures 3--4 and 3--5.)

STEP	CONNECTIONS ON TS-58/GRM-1	DIAL SETTING	TRANSMITTER OPERATION	ADJUST
1	Connect Phantom Antenna to transmitter antenna post.		Turn transmitter ON. Key transmitter. Check FREQUENCY against crystal frequency by tuning for greatest shadow on resonance indicator.	FREQUENCY knob
2		T-18 2.9 mc T-19 3.9 mc T-20 5.2 mc T-21 6.9 mc T-22 9.0 mc	Turn FREQUENCY dial to setting indicated; Emission switch to VOICE. Key transmitter. Load transmitter by adjusting for maximum antenna current.	ANT IND. ANT COUP.
3	Frequency meter loosely coupled to dummy load and set to same frequency.	Same as Step 2.	Adjust master oscillator trimmer for zero-beat in frequency meter headphones. (See Transmitter Alignment Notes, paragraph 3--9.)	E-62
4	Same as Step 3.	T-18 2.2 mc	Turn FREQUENCY dial to setting indicated. Vary	E-58

		<p>T-19 3.1 mc</p> <p>T-20 4.1 mc</p> <p>T-21 5.4 mc</p> <p>T-22 7.1 mc</p>	<p>FREQUENCY dial for zero-beat and note error. To correct, adjust master oscillator inductance. (See Transmitter Alignment Notes, paragraph 3--10.)</p>	
5	<p>Repeat Steps 3 and 4 until the final setting of E-62 with to cover in place is at a mid-position and dial setting at the high and low is accurate. Dial setting should be within 0.03 per cent of actual frequency as indicated by LM frequency meter.</p>			
6	<p>Remove Phantom Antenna to align R-F amplifier. Remove frequency meter and coupling. TS-58/GRM-I switch to position 5.</p>	<p>Same as Step 2.</p>	<p>Adjust for minimum R-F amplifier plate current, which should be below 10 divisions (25 ma) on TS-58/GRM-1 meter.</p>	<p>C-67 (normally locked)</p>
7		<p>Same as Step 4.</p>	<p>Turn FREQUENCY dial to setting indicated to check tracking; note if the minimum R-F plate current is within 10 ma of the minimum obtained in Step 6. To correct, adjust iron core. (See Transmitter Alignment Notes, paragraph 3--1 l.)</p>	
8	<p>Repeat Steps 6 and 7 until R-F amplifier is operating at minimum plate current at the high frequency end and until tracking error is corrected.</p>			
9	<p>Reconnect Phantom Antenna to transmitter antenna post.</p>		<p>Adjust transmitter for maximum antenna current output. Lock all dial controls at completion of this check.</p>	<p>ANT IND. ANT COUP.</p>

SECTION IV TROUBLE ISOLATION

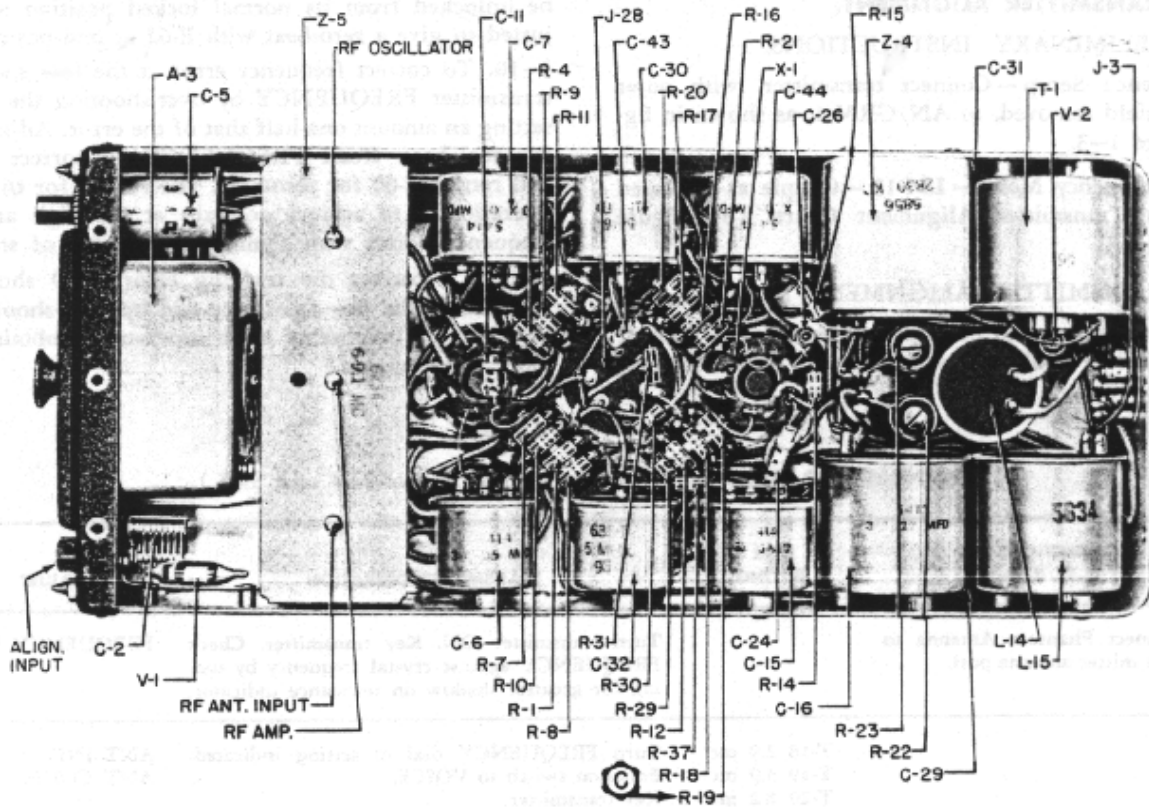

Figure 4-1. Typical Communications Receiver, Bottom View

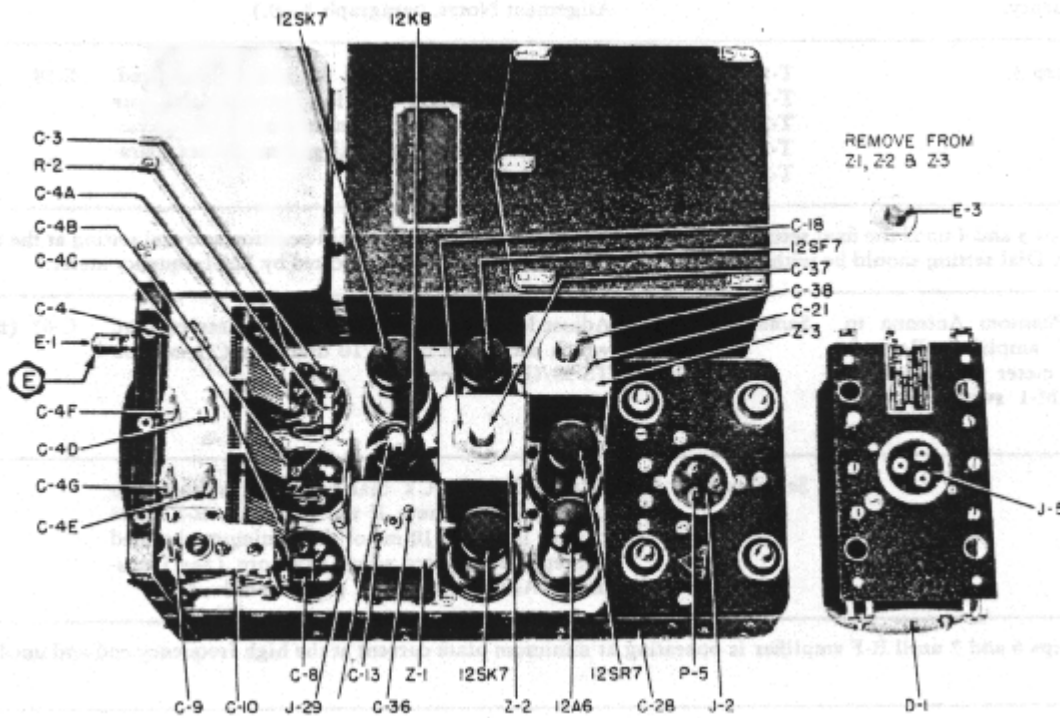

Figure 4-2. Typical Receiver, Top View Inside, and Bottom View Dynamotor

4--1. RADIO RECEIVER.

4--2. DYNAMOTOR UNIT.4--3. PRELIMINARY INSTRUCTIONS: All tests on the receiver will be performed using the AN/GRM-1 Test Setup, as shown in figure 1--3.

STEP	TEST POINT	TEST EQUIPMENT CONTROLS	NORMAL INDICATION	POSSIBLE CAUSES OF ABNORMAL INDICATION
1.	A	Control switch to MCW or CW position. Meter switch to position 3.	Dynamotor scans; I-104-A meter indicates from 46 to 50 (230 to 250 volts dc):	Shorted or open dynamotor windings; defective plugs or jacks; open choke L-14, L-15.
2.	B	Control switch to MCW or CW position. Meter switch to position 1 and 2.	Position 1; meter reads 56 (28 volts dc). Position 2; meter reads 14 to 17 (1.4-1.7 amps).	Blown fuses; defective plugs or jacks; open wiring, shorted or open dynamotor windings.

4--4. AUDIO-FREQUENCY CIRCUIT.

(See chart below.)

4--5. PRELIMINARY INSTRUCTIONS: Set Audio Signal Generator to 1000 cycles, zero output. Connect TS-375/U or TS-352/U a-c test leads across Audio Signal Generator output terminals. Connect the other pair of test leads from Audio Signal Generator output terminals to indicated test points and chassis.

STEP	TEST POINT	TEST EQUIPMENT CONTROLS	ARC-5 RECEIVER CONTROLS	NORMAL INDICATION	POSSIBLE CAUSES OF ABNORMAL INDICATION
1	C	Set voltmeter on 3 (or 2.5) volt a-c range. Advance the output level control on Audio Signal Generator for 2.25 volt reading on voltmeter.	Control switch to MCW position.	Output meter reading of 200 milliwatts or greater.	If normal, proceed to paragraph 4--6. If not, proceed with Step 2, paragraph 4--5.
2	D	Same as Step 1.	Same as Step 1.	Same as Step 1.	Faulty power amplifier tube and/or circuit components, Repair and return to Step 1, paragraph 4--5 before going to paragraph 4--

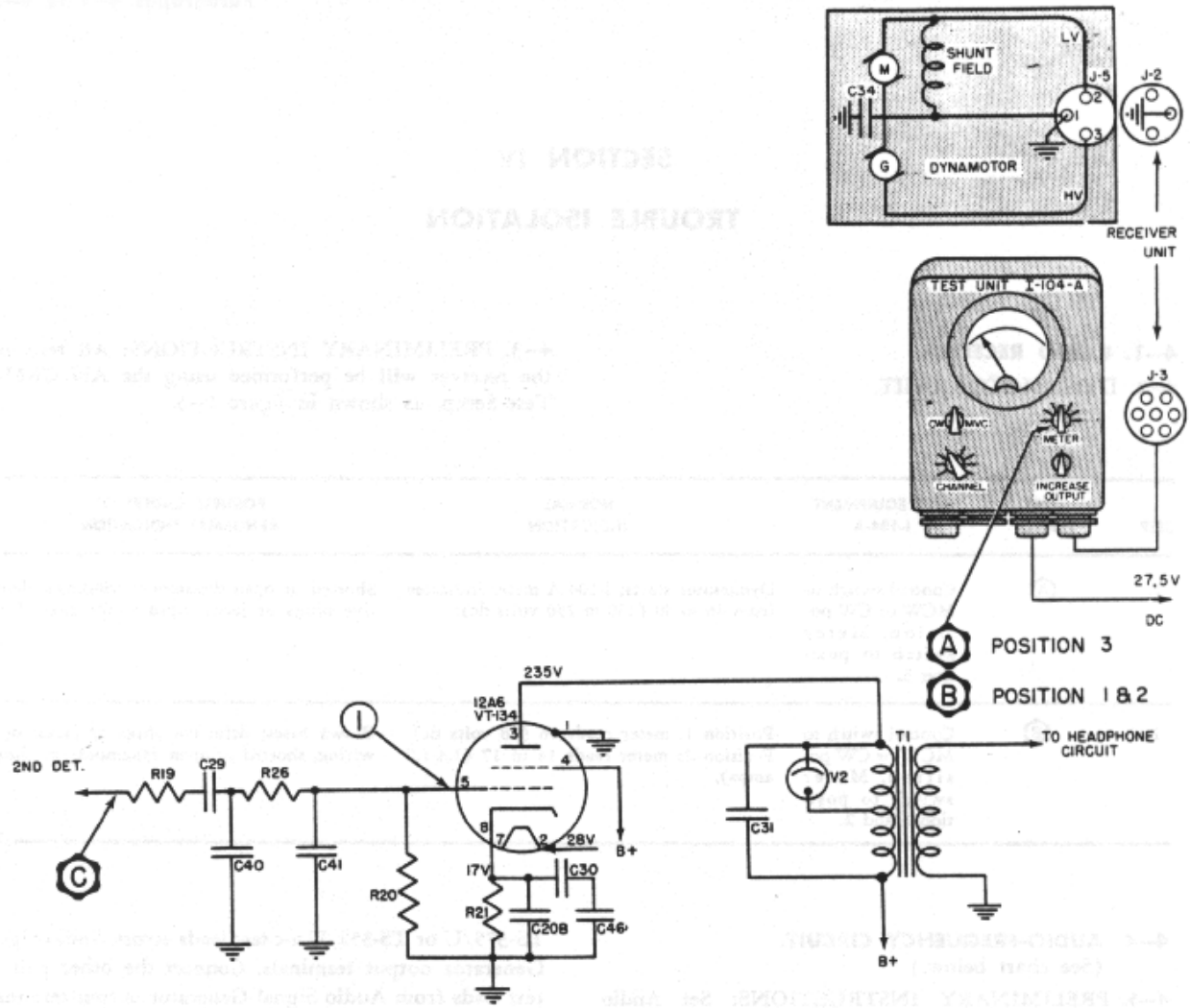
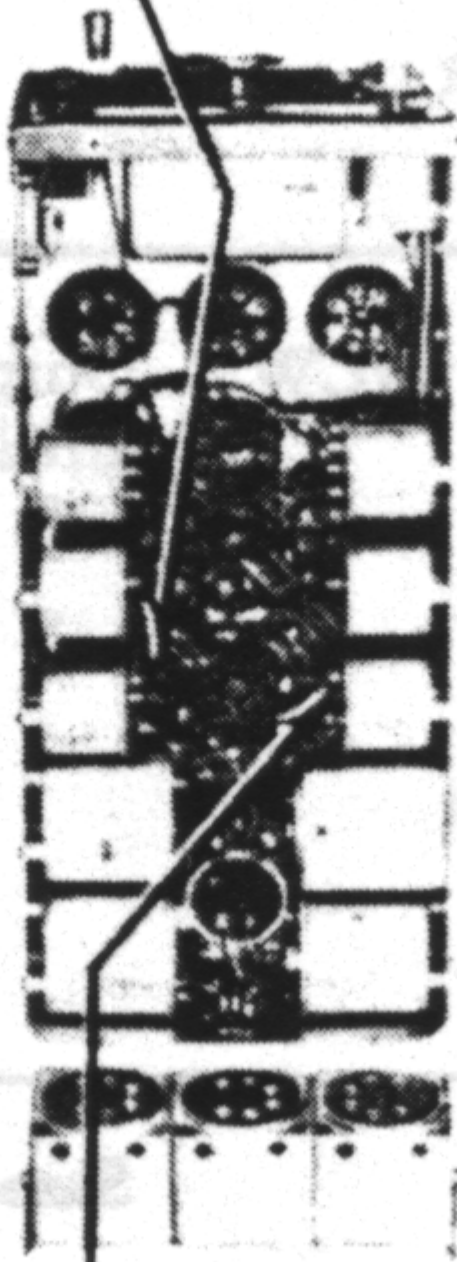

Figure 4-3. Dynamotor Test Points

① (R-19)



① (PIN 5)

Figure 4-4. Audio Frequency Test Points

4--6. INTERMEDIATE-FREQUENCY CIRCUIT.

(Follow chart below.)4--7. PRELIMINARY INSTRUCTIONS: Insert a 0.006 ufd capacitor in series with the "hot" lead from the Signal Generator to the receiver. Use a signal modulated 30 per cent at 400 or 1000 cycles. Connect Signal Generator to indicated TEST POINT.

STEP	TEST POINT	TEST EQUIPMENT CONTROLS		ARC-5 RECEIVER CONTROLS	NORMAL INDICATION	POSSIBLE CAUSES OF ABNORMAL INDICATION			
1	D	Tune the Signal Generator to the following appropriate frequency. (Rock the Signal Generator FREQUENCY dial for maximum output meter reading.)		Set the CONTROL switch on the I-104-A Test Unit to MCW position.	Output of 10 milliwatts or greater across the 300-ohm load, for Signal Generator input as follows:	If normal, proceed to Step 1, paragraph 4--8. If not, proceed to Step 2, paragraph 4--7.			
							UNIT	FREQUENCY	
							.19-.55 mc	85 kc	310 uv
							.52-1.5 mc	239 kc	360 uv
							1.5-3.0 mc	705 kc	910 uv
							3.0-6.0 mc	1415 kc	330 uv
							6.0-9.1 mc	2830 kc	430 uv
2	1	Same as in Step 1.		Same as in Step 1.	Same output as in Step 1. Signal Generator input as follows:	If normal, trouble it in converter stage. If not normal proceed to Step 3, paragraph 4--7.			
							8100 uv		
							7500 uv		
							10,000 uv		
							2400 uv		
					2500 uv				

3	2	Same as in Step 1.	Same as in Step 1.	Same output as in Step 1. Signal Generator input as follows:	If normal, trouble is in 1st I-F stage. If not normal, trouble is probably in 2nd I-F stage.
				210,000 uv	
				220,000 uv	
				130,000 uv	
				99,000 uv	
				85,000 uv	

Note

When a stage is found defective, test the tube in a tube checker and replace with good tube if necessary. Conduct routine resistance and voltage measurements to locate the defective or faulty component or components within a stage. When trouble has been located and corrected, return to Step 1, paragraph 4--7 to determine that I-F stages are operating satisfactorily.

4--8. CONVERTER CIRCUIT.(Follow chart below).

4--9. PRELIMINARY INSTRUCTIONS: Use a signal 50 per cent modulated at 400 or 1000 cycles. Connect R-F Signal Generator between the TEST POINT and chassis. When using the VTVM, the d-c probe having several megohms of series isolating resistance inserted at its tip should be used. (See figures 4--7 and 4--8.)

STEP	TEST POINT	TEST EQUIPMENT CONTROLS		ARC-5 RECEIVER CONTROLS	NORMAL INDICATION	POSSIBLE CAUSES OF ABNORMAL INDICATION
1	1	Tune the Signal Generator to the following appropriate frequency. (Rock the Signal Generator FREQUENCY dial for maximum output.)		Set the CONTROL switch on the I-104-A Test Unit to MCW position.	Output of 10 milliwatts or greater across the 300-ohm load, for Signal Generator input as follows:	Defective 12K8 tube; defective circuit components; improper alignment. (Proceed to step 2 to check the oscillator circuit.) If normal, proceed to step 1, paragraph - 4--10.
		UNIT	FREQUENCY	FREQUENCY	NORMAL SENS.	
		.19-.55 mc	.55 mc	.55 mc	370 uv	
		.52-1.5 mc	1.5 mc	1.5 mc	430 uv	
		1.5-3.0 mc	3.0 mc	3.0 mc	990 uv	
		3.0-6.0 mc	6.0 mc	6.0 mc	390 uv	
		6.0-9.1 mc	9.1 mc	9.1 mc	480 uv	
2	2	Set VTVM to 12-volt d-c range, negative polarity. Connect d-c probe to TEST POINT.		Vary the frequency from the high end to the low end of the dial.	VTVM indicates a - 6 to -9 volts. This voltage varies over the frequency range.	Weak or defective oscillator section of 12K8 converter tube. Defective components. Improper alignment.

4--10. RADIO-FREQUENCY CIRCUIT.

(Follow chart below).

STEP	TEST POINT	TEST EQUIPMENT CONTROLS		ARC-5 RECEIVER CONTROLS	NORMAL INDICATION	POSSIBLE CAUSES OF ABNORMAL INDICATION
1	1	Same as Step 1, paragraph 4--8.		Control to MCW	Loud clear tone.	R-F tube or circuit. If normal proceed to Step 1, paragraph 4--11.
		UNIT	FREQUENCY	FREQUENCY	NORMAL SENS.	
		.19-.55 mc	.55 mc	.55 mc	50 uv	
		.52-1.5 mc	1.5 mc	1.5 mc	80 uv	
		1.5-3.0 mc	3.0 mc	3.0 mc	150 uv	
		3.0-6.0 mc	6.0 mc	6.0 mc	130 uv	
		6.0-9.1 mc	9.1 mc	9.1 mc	100 uv	

4--11. ANTENNA CIRCUIT.

(Follow chart below).

STEP	TEST POINT	TEST EQUIPMENT CONTROLS		ARC-5 RECEIVER CONTROLS	NORMAL INDICATION	POSSIBLE CAUSES OF ABNORMAL INDICATION
1.	E	Same as Step 1, paragraph 4--8		Control to MCW	Loud clear tone in headset.	Antenna circuit. If normal, this completes the receiver check.
		UNIT	FREQUENCY	FREQUENCY	NORMAL SENS.	
		.19-.55 mc	.55 mc	.55 mc	5 uv	
		.52-1.5 mc	1.5 mc	1.5 mc	7 uv	
		1.5-3.0 mc	3.0 mc	3.0 mc	7 uv	
		3.0-6.0 mc	6.0 mc	6.0 mc	6 uv	
		6.0-9.1 mc	9.1 mc	9.1 mc	6 uv	

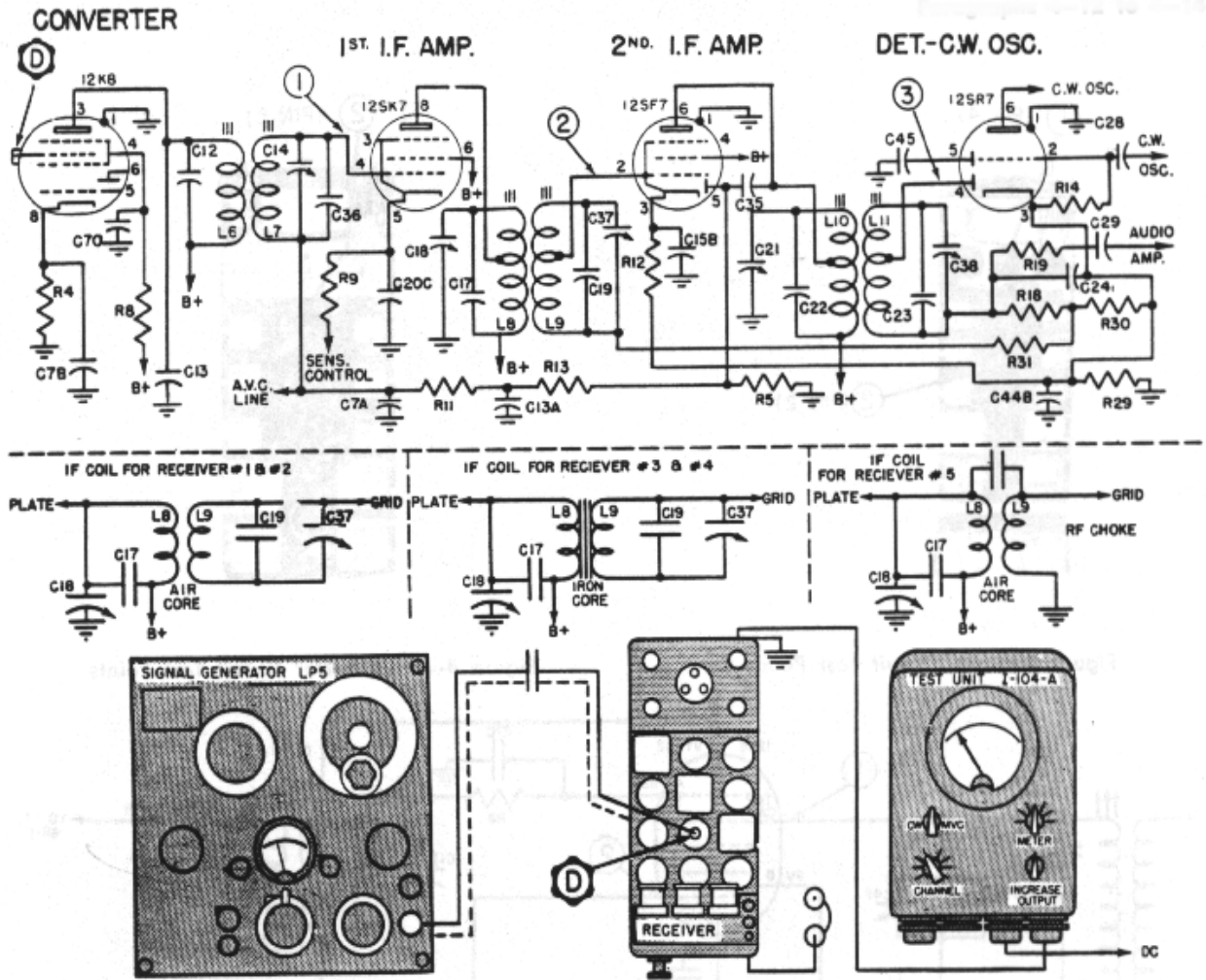

Figure 4-5. Circuit Test Point Diagram

4--12. TRANSMITTER AND MODULATOR.

4--13. DYNAMOTOR UNIT.

4--14. PRELIMINARY INSTRUCTIONS: All tests on the transmitter will be performed using the AN/GRM-1 Test Setup optional wiring, illustrated in Figure 1--3, or the AN/ARC-5 Test Bench Harness. Select transmitter one or two, corresponding to the desired unit's position in the test rack. (See figure 4--15.)

STEP	TEST POINT	TEST EQUIPMENT CONTROLS	NORMAL INDICATION	POSSIBLE CAUSES OF ABNORMAL INDICATION
1.	F	Emission selector switch to CW. TRANS. POWER switch to ON. Switch on TS-58 set to position 1.	Filaments light; relays K-50, K-53, and K-54 energized; dynamotor runs. TS-58 meter indicates 54 (27 volts).	Fuses F-50 and F-51 blown; defective coils on relays; dirty or corroded contacts; defective dynamotor.
2.	G	Switch on TS-58 set to position 3. Key the transmitter.	TS-58 meter reads 51-55 (510-550 volts d-c.)	Defective relay K-52; defective dynamotor windings; shorted C-55; shorted components in 550-volt circuit; defective plugs and jacks on equipment.

① (PIN 4)

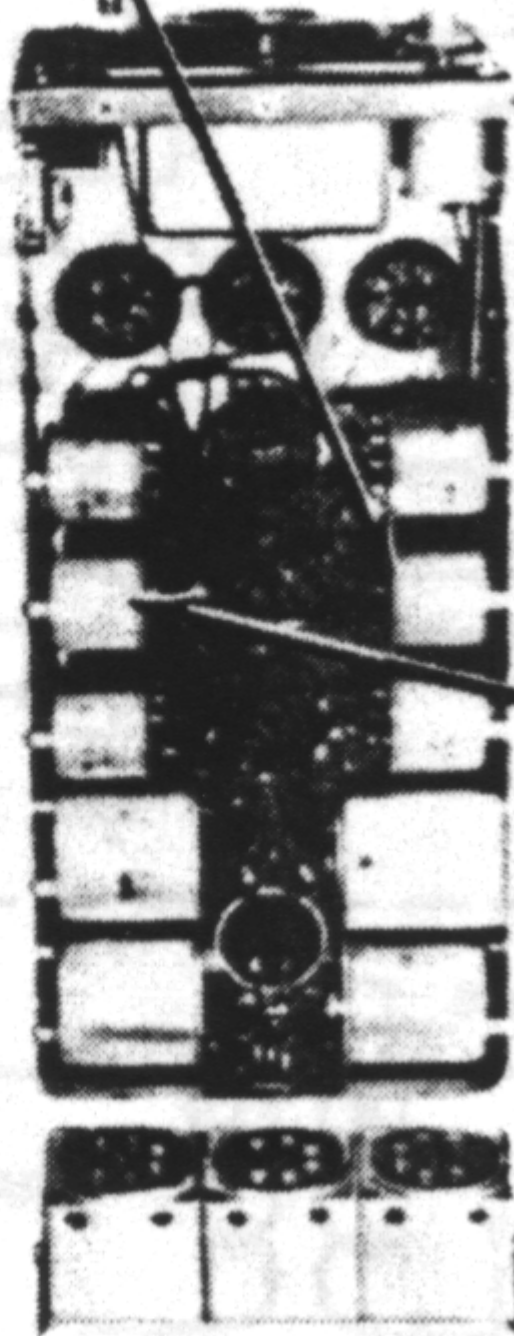

② (PIN 2)

Figure 4-6. Circuit Test Points

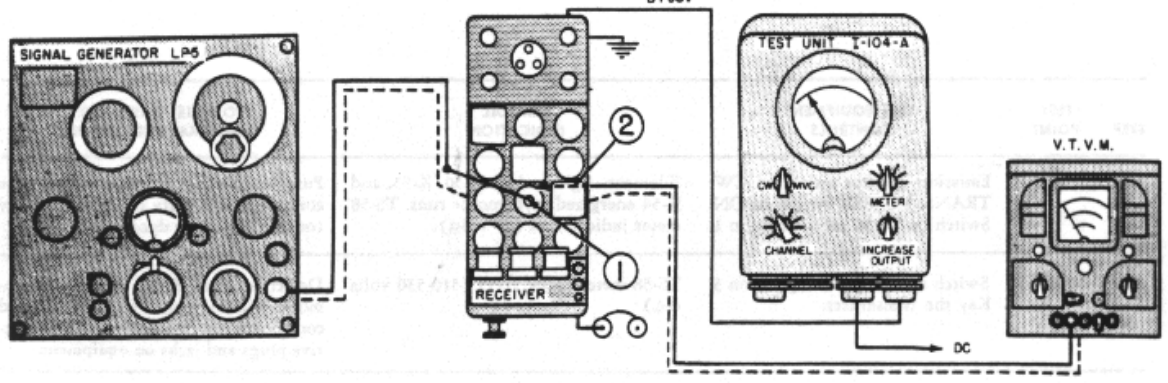
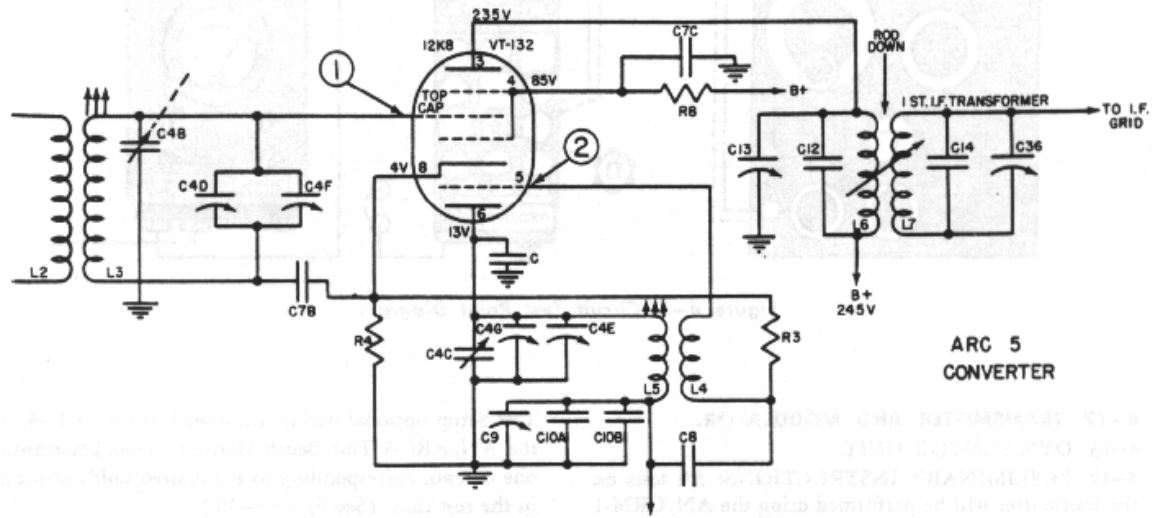

Figure 4-7. Converter Circuit Test Points

② (PIN 5)

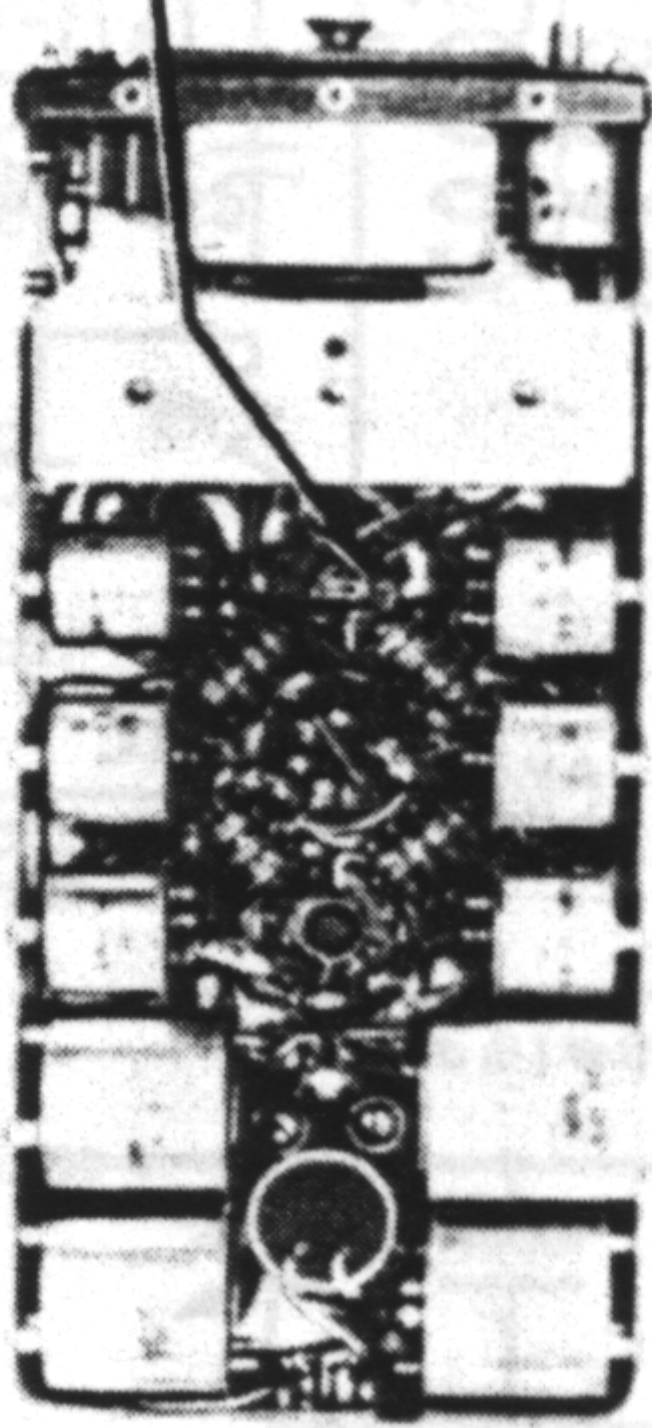

Figure 4-8. Converter Circuit Test Points

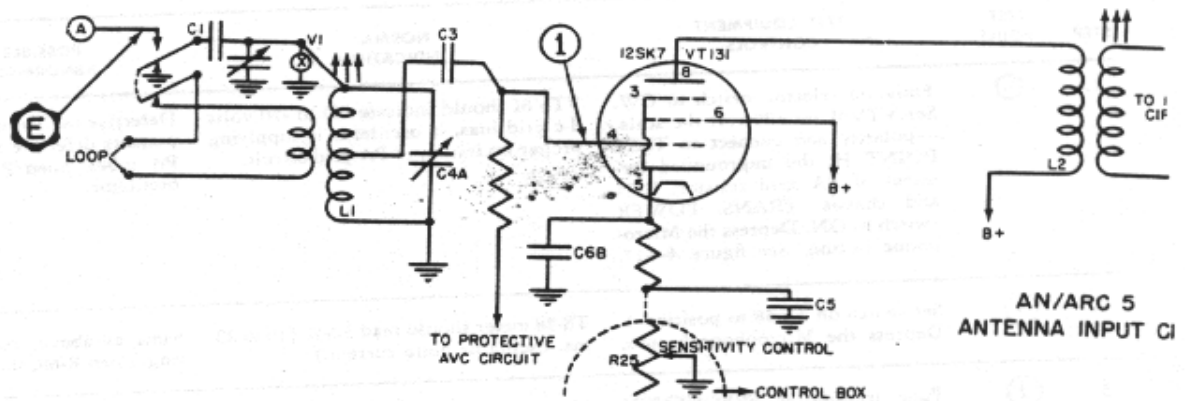

Figure 4-9. Antenna Circuit Test Diagram

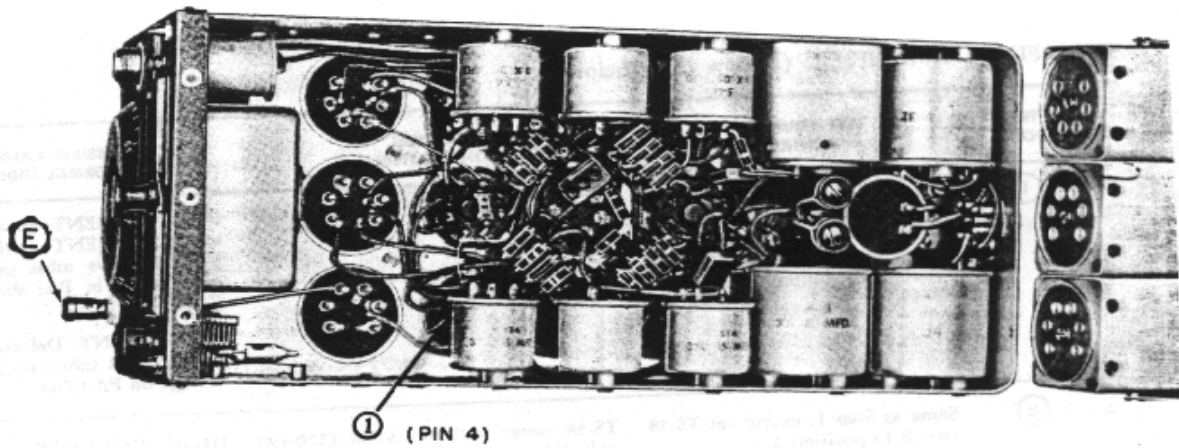

Figure 4-10. Antenna Circuit Test Points

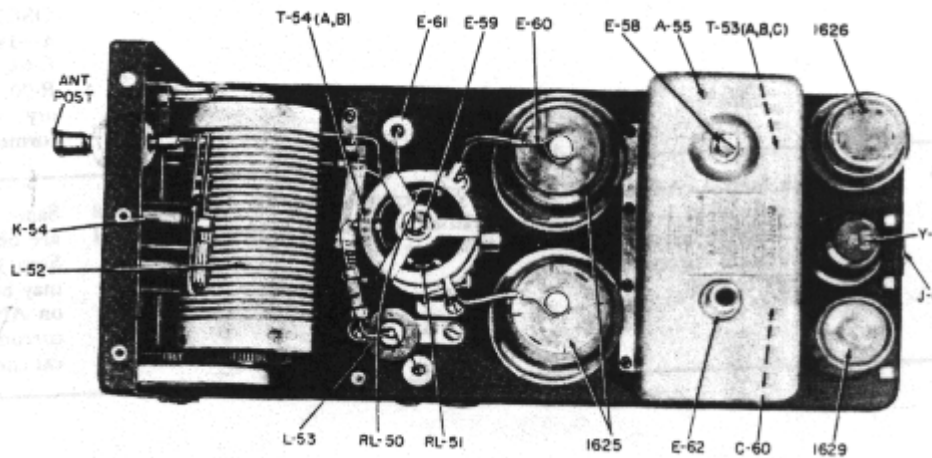

Figure 4-11. Typical Transmitter, Top View, Shield Removed

4--15. OSCILLATOR.

(Follow chart below.)

STEP	TEST POINT	TEST EQUIPMENT CONTROLS	NORMAL INDICATION	POSSIBLE CAUSES OF ABNORMAL INDICATION
1.		<p>Emission selector switch to CW. Set VTVM on 120-volt d-c scale, --polarity and connect to TEST</p> <p>POINT H, the ungrounded terminal of PA grid resistor, R-74 and chassis. TRANS. POWER switch to ON. depress the Microphone button. See figure 4--17.</p>	<p>VTVM should indicate -40 to -70 volts d-c grid bias, if oscillator is supplying proper excitation to PA grid circuit.</p>	<p>Defective oscillator tube or circuit components defective relay K-53; defective PA tubes; open R-74; low voltage on oscillator.</p>
2.		<p>Set switch on TS-58 to position 4. Depress the Microphone button.</p>	<p>TS-58 meter should read 32-46 (16 to 23 ma. oscillator plate current.)</p>	<p>Same as above; oscillator not oscillating; open R-68, shorted C-58A.</p>
3.		<p>Tune transmitter FREQUENCY dial to calibrator crystal frequency. Depress the Microphone button.</p>	<p>Maximum shadow angle on the "Magic Eye" tube screen as the FREQUENCY dial is rotated to the crystal frequency.</p>	<p>Same as above; defective "Magic Eye" tube; defective crystal; no or low voltages.</p>

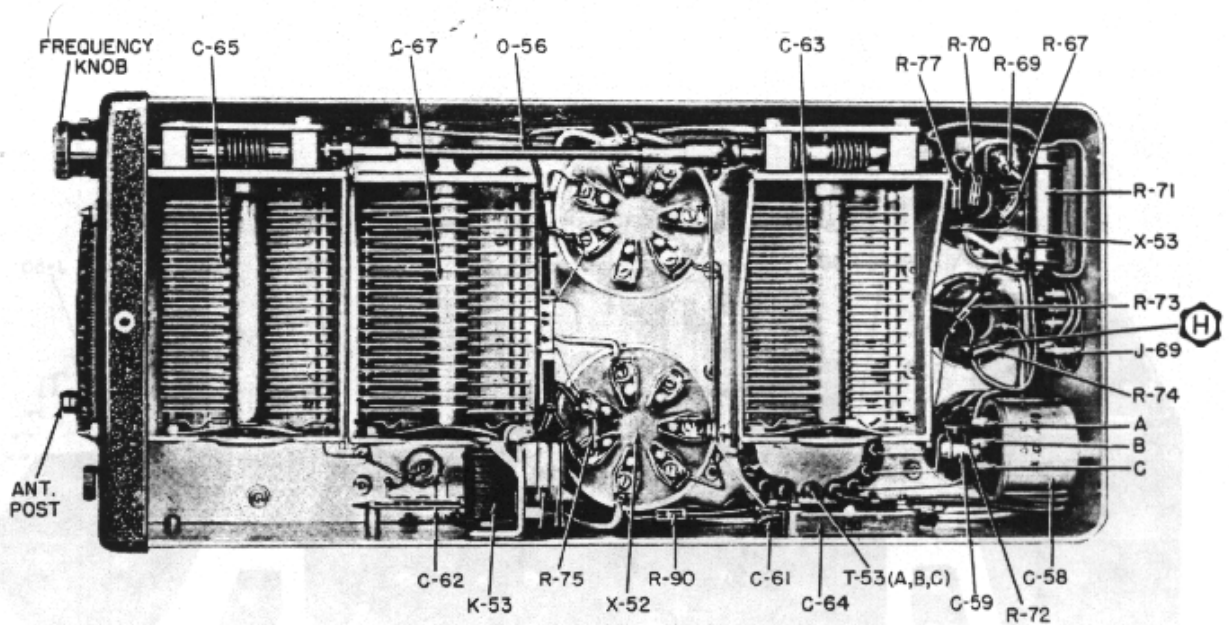

Figure 4-12. Typical Transmitter, Bottom View

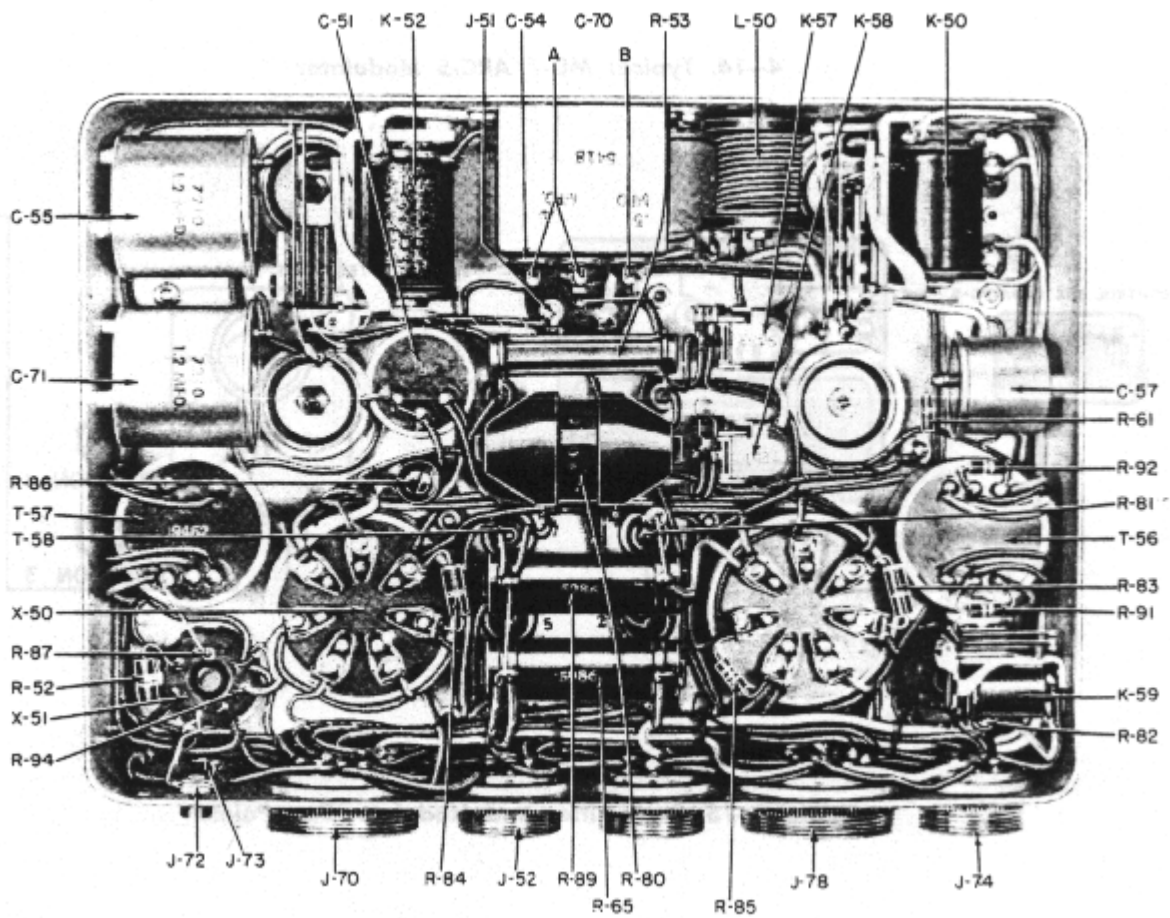

Figure 4-13. Modulator, Type MD-7/ARC-5, Bottom View

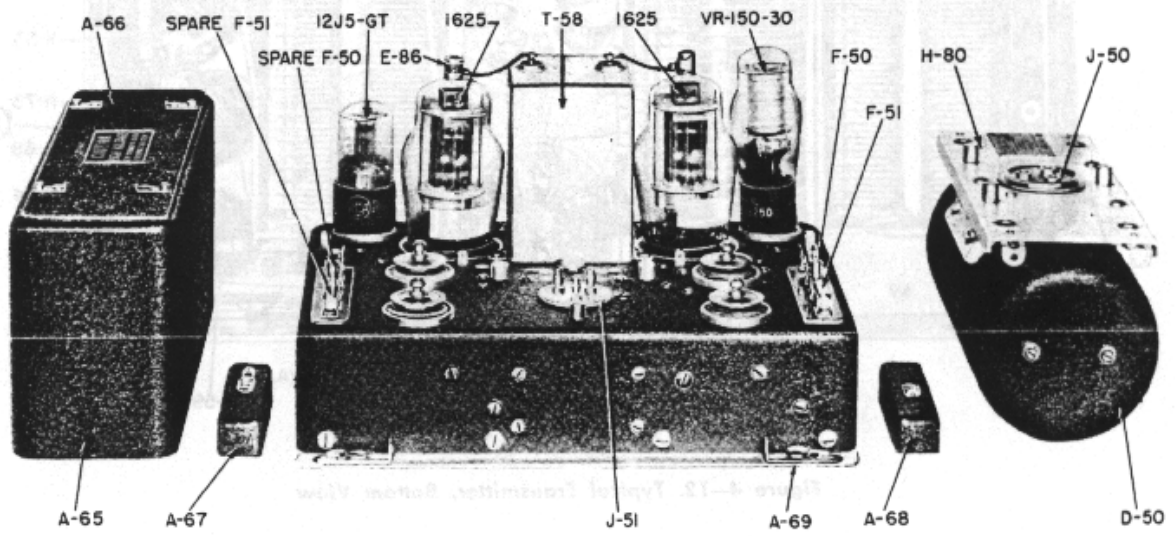

Figure 4-14. Typical MD-7/ARC-5 Modulator

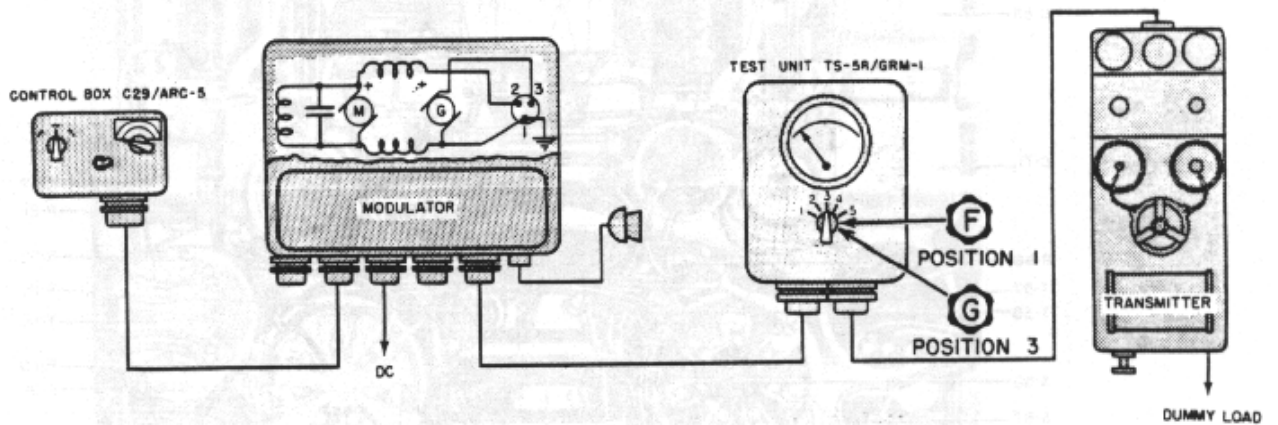

Figure 4-15. Transmitter and Modulator Test Points

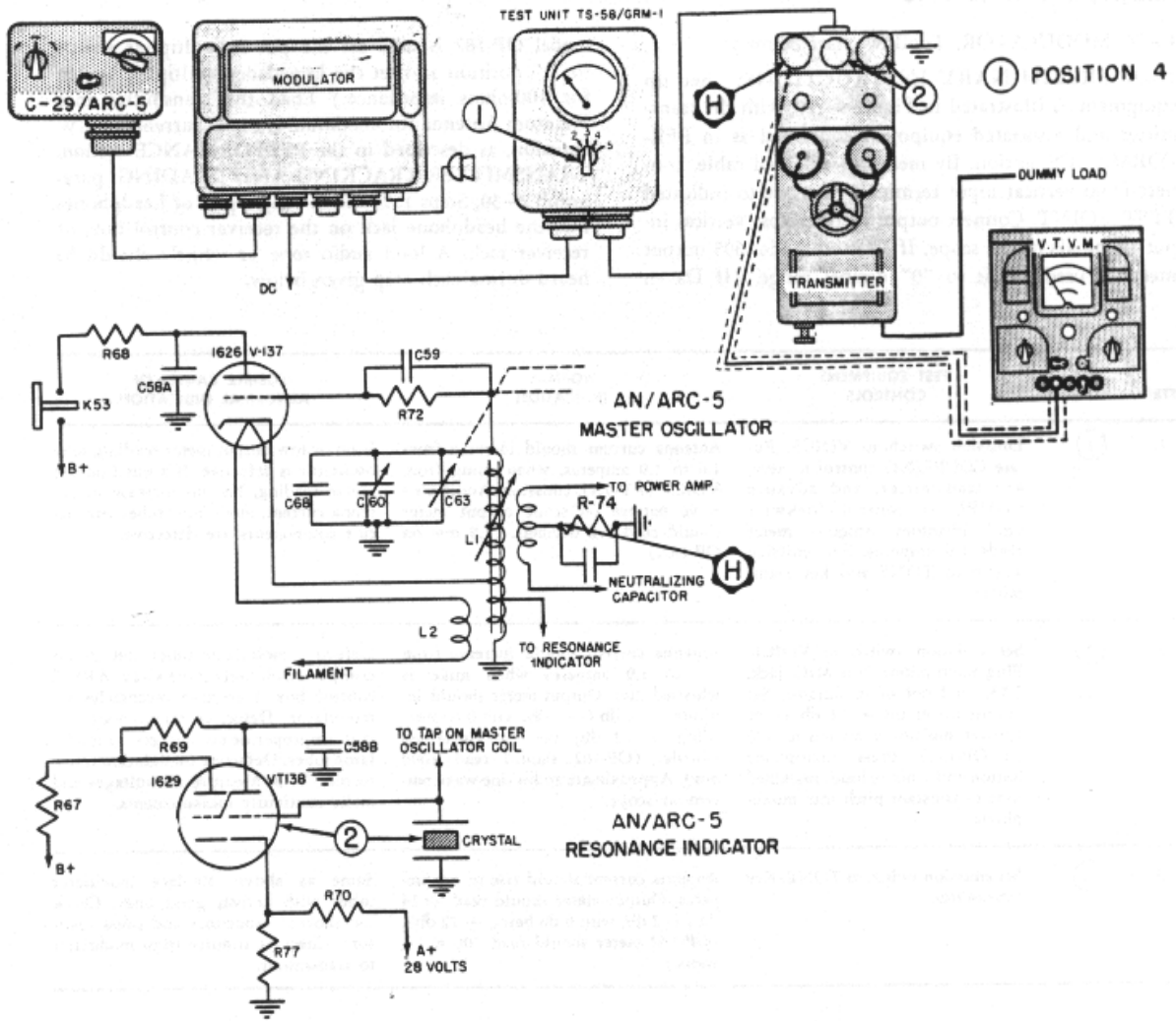

Figure 4-16. Diagram

H

(R-74)

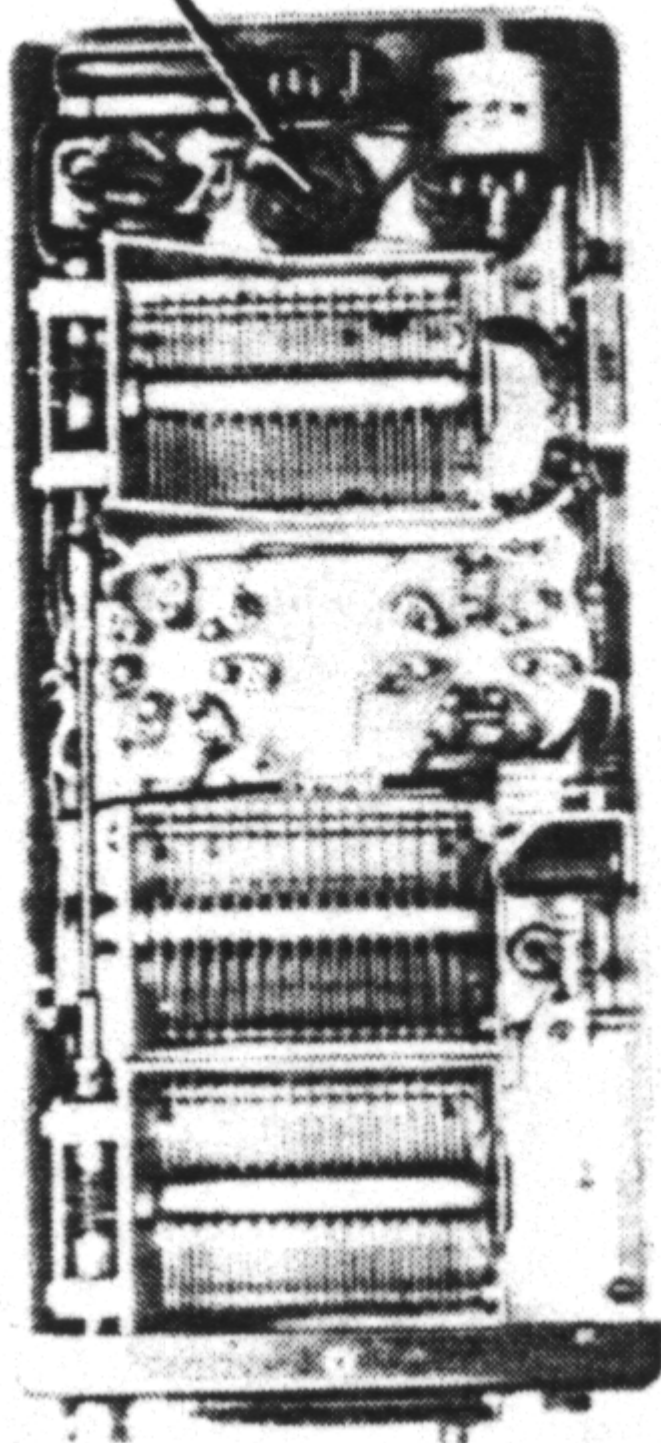

Figure 4-17. Oscillator Check Points

4--16. FINAL AMPLIFIER.

(Follow chart below.)

STEP	TEST POINT	TEST EQUIPMENT CONTROLS	NORMAL INDICATION	POSSIBLE CAUSES OF ABNORMAL INDICATION
1.		<p>Emission switch to CW. Power switch to ON. Set COUPLING control to zero. Set the TS-58 switch to position 5. Press the Microphone button. (See figure 4--19.)</p>	<p>TS-58 meter indicates I0 (25 ma final PA plate current.)</p>	<p>HIGH CURRENT: Poor tracking, refer to ALIGNMENT section, paragraph 3--5; defective tubes or other circuit components in PA; shorted capacitor C-72.</p> <p>NO CURRENT: Defective relay K-53; defective PA tubes; no plate or screen voltage on PA tubes.</p>
2.		<p>Same as Step 1, except set TS-58 switch to position 2.</p>	<p>TS-58 meter indicates 34-38 (170-190 volts PA screen voltage.)</p>	<p>HIGH VOLTAGE: Defective PA tubes; defective R-89.</p> <p>LOW VOLTAGE: Insufficient excitation; refer to TROUBLE ISOLATION, OSCILLATOR section, paragraph 4--14; shorted screen by-pass capacitors C-64, C-75, C-71; open screen resistors R-90, R-94, R-81 and R-89; open secondary windings on modulation transformer T-58.</p>
3.		<p>Same as Step 1, advance COUPLING control to 3. Adjust ANT</p>	<p>ANT current of over 2.0 amperes. TS-58 reading of 60 to 80 (150</p>	<p>Same as above: if normal indications are obtained in</p>

		INDUCTANCE control for maximum PA plate current and maximum ANT current.	to 200 ma final PA plate current.)	Steps 1 and 2, but not Step 3, relay K-54 (K-55 also, if used) may be defective. Sliding roller contact on ANT TUNING coil may be dirty, corroded, and not making good electrical contact.
--	--	--	------------------------------------	--

4--17. MODULATOR.

(Follow chart below.)

4--18. PRELIMINARY INSTRUCTIONS: Set up equipment as illustrated in Figure

4--19, with the transmitter and associated equipment connected as in PERFORMANCE section. By means of shielded cable, connect from vertical input terminals of scope to indicated TEST POINT. Connect output meter across vertical input terminals of the scope. If Weston model 695 output meter is used, set it to "0" decibel range. (If Daven model OP-182 is used set the power multiplier switch to "1" position and set the impedance multiplier switch Phantom Antenna for maximum antenna current, on CW emission, as described in the PERFORMANCE section, TRANSMITTER TRACKING AND LOADING, paragraph 2-30, Steps 1, 2, and 3. Plug a pair of headphones into the headphone jack on the receiver control box, or receiver rack. A loud audio tone or whistle should be heard during each Step given below.

STEP	TEST POINT	TEST EQUIPMENT CONTROLS	NORMAL INDICATION	POSSIBLE CAUSES OF ABNORMAL INDICATION
1.		<p>Emission switch to VOICE. Ro-</p> <p>tare COUPLING control to zero,</p> <p>key transmitter, and advance</p> <p>COUPLING control clockwise</p> <p>until Phantom Antenna meter</p> <p>reads 1.6 amperes. Set emission</p> <p>switch to TONE and key transmitter.</p>	<p>Antenna current should increase from</p> <p>1.6 to 1.9 amperes, when going from</p> <p>VOICE to TONE emission. Audio sine</p> <p>wave pattern scope output meter</p> <p>should read +2 decibels. (1.5 mw on OP-182.)</p>	<p>If no or low output meter reading, tone</p> <p>oscillator is defective. If normal output</p> <p>meter reading, but no increase in an-</p> <p>tenna current, modulator tubes and cir-</p> <p>cuit components are defective.</p>
2.		<p>Set emission switch to VOICE.</p> <p>Plug microphone into MIC. jack,</p> <p>J-73, on front of modulator. Set</p> <p>output meter on + 12 db range</p> <p>(power multiplier switch to 100</p>	<p>Antenna current should increase from 1.6 to 1.9 amperes when mike is Whistled into. Output meter should indicate + 14 db (+ 2 db, with 0 db now being + 12 db) on loud sustained whistle. (OP-182 should read 1000 mw). Approximate audio sine wave pattern on 'scope.</p>	<p>Defective modulator tubes and circuit</p> <p>components. defective C-29/ARC-5 control box. Defective receptacles on</p> <p>modulator. Defective microphone circuit. Improper or no voltages on modulator tubes. Defective modulation transformer T-58.</p>

		<p>on OP-182). Press microphone button and whistle loud, sustained tone of constant pitch into microphone.</p>		<p>Measure all voltages and make continuity measurements.</p>
3.		<p>Set emission switch to TONE. Key transmitter.</p>	<p>Antenna current should rise to 1.9 amperes. Output meter should read + 14 db (+ 2 db, with 0 db being + 12 db). (OP-182 meter should read 700 milliwatts.)</p>	<p>Same as above. Replace modulator tubes with known good ones. Check for shorted capacitors and open resistors. Check continuity from modulator to transmitter.</p>

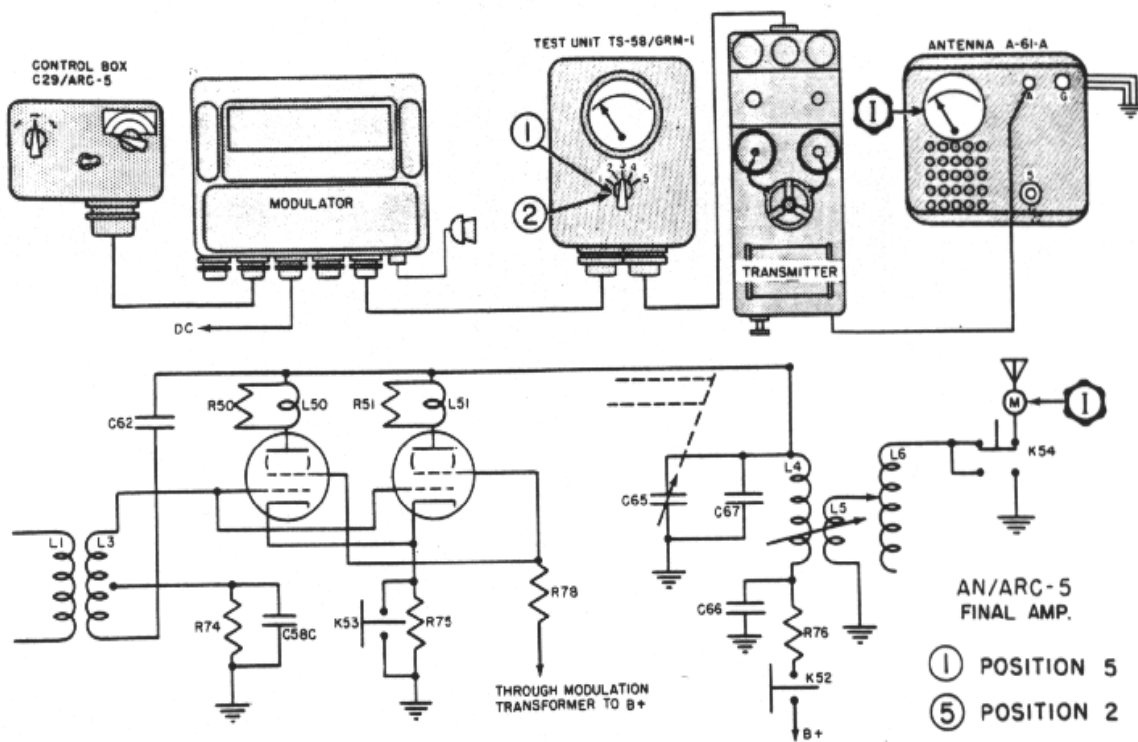

Figure 4-18. Final Amplifier Check Diagram

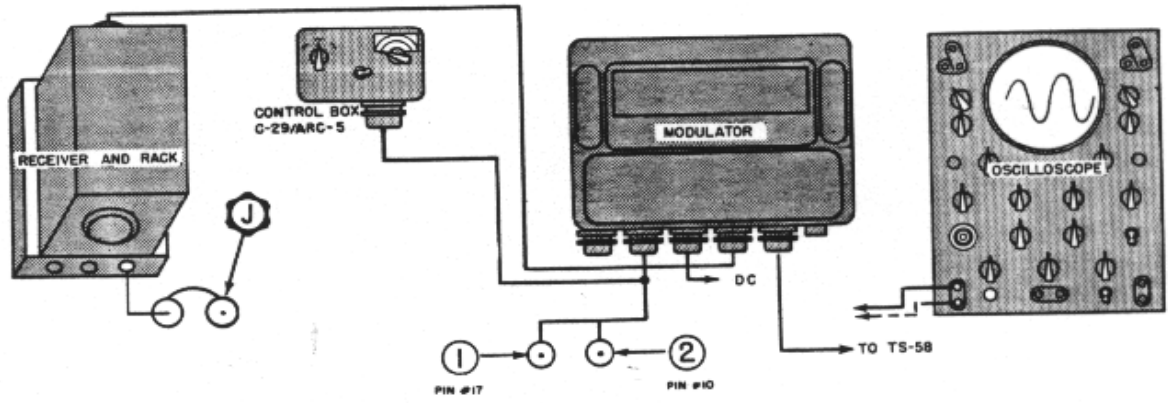

Figure 4-19. Modulator Check Diagram